

LINEAR

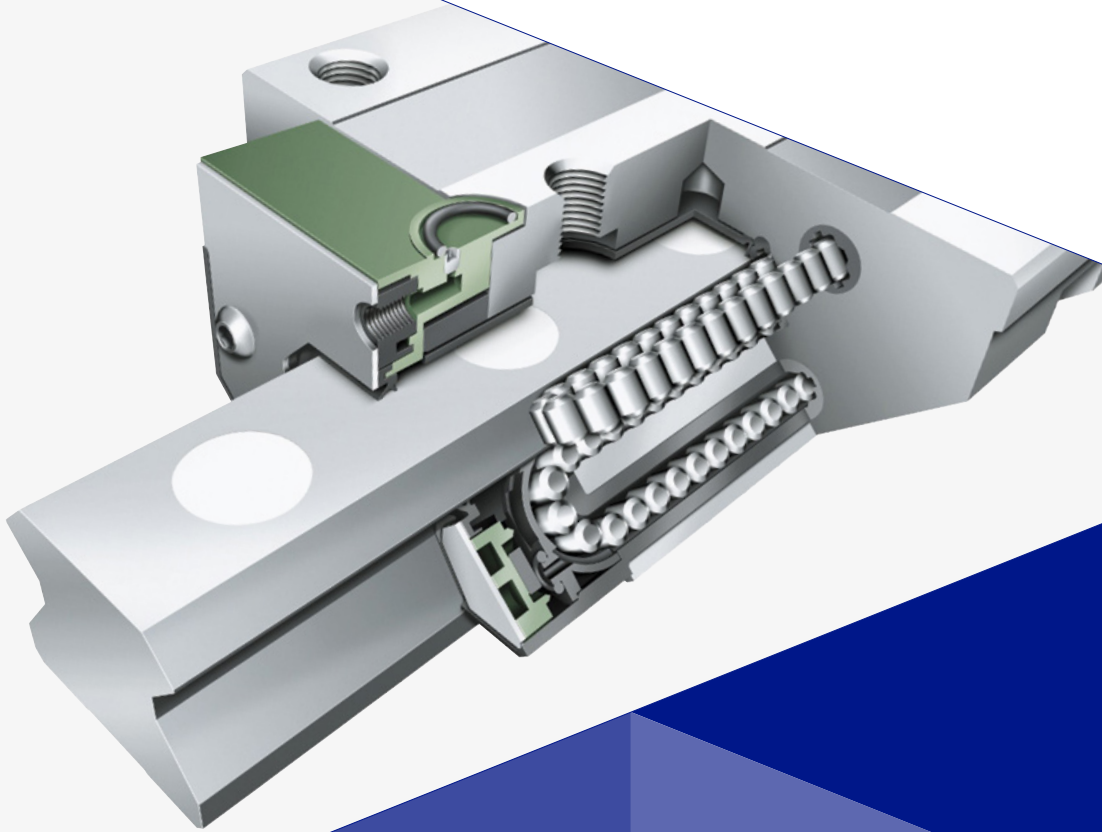

M
WILHELMSSEN A/s

www.mw.dk · +45 86 15 01 11 · mw@mw.dk

Kapitel 3: Linear

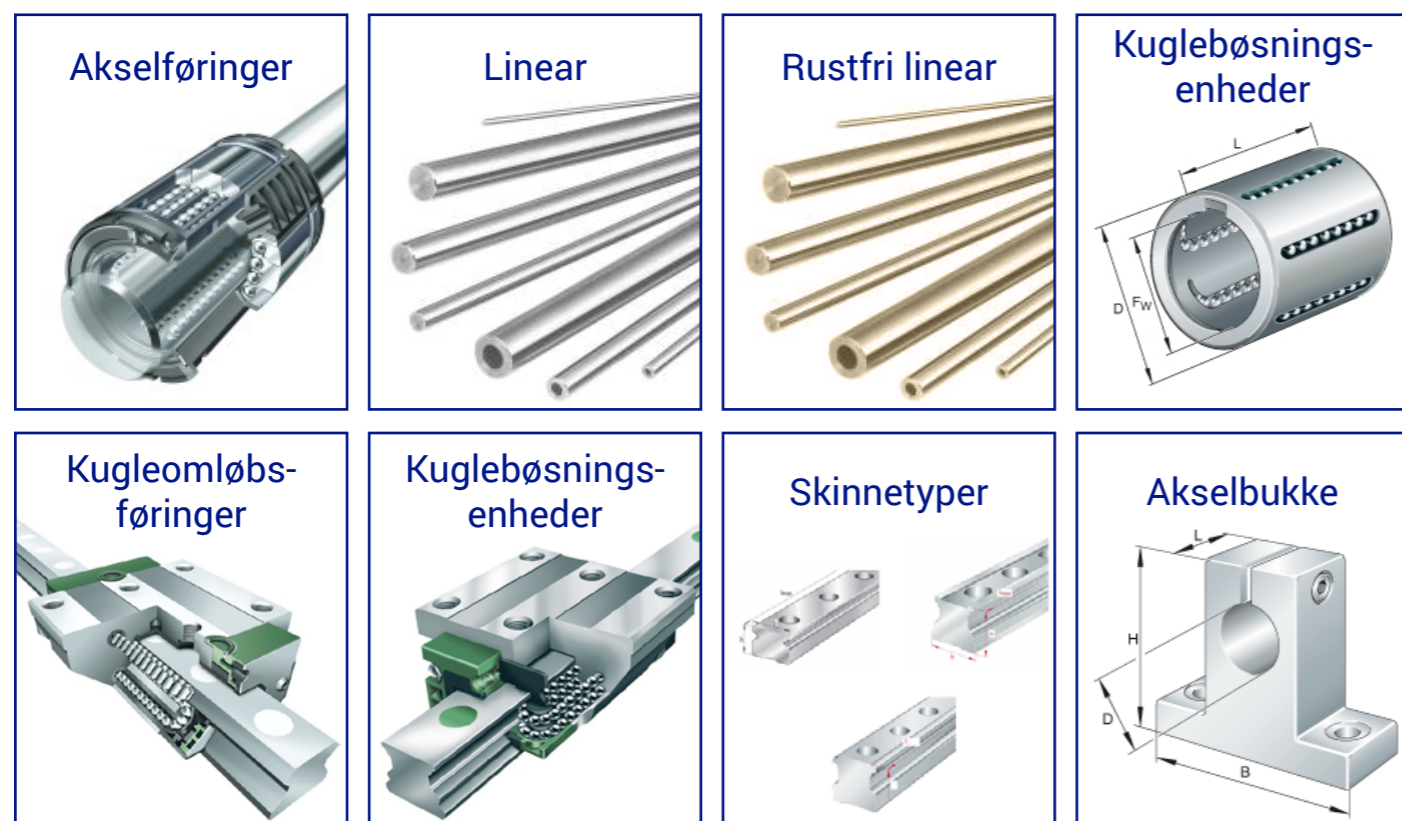

Vi lagerfører INA's komplette program i linear teknologi og kan levere fra dag til dag.

Øvrige mærker kan leveres inden for få dage.

- | | | |
|-----------|------------------|----------------|
| • SKF | • Bosch Rexroth | • NSK |
| • Rexroth | • Danaher Motion | • Schneeberger |
| • THK | • Hepco | • Sferax |
| • IKO | • Igus | |

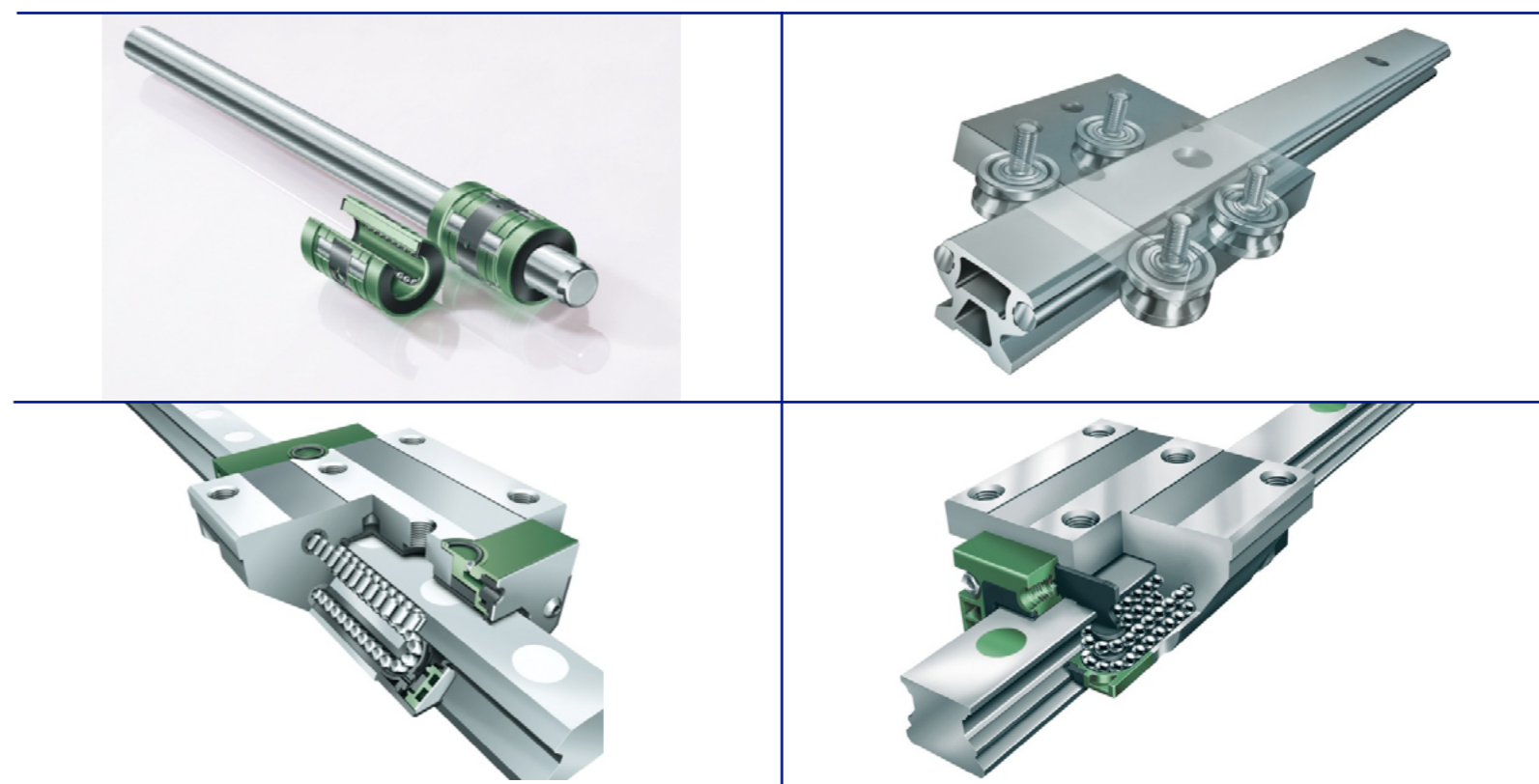

De kan finde yderligere komponenter i vores e-handel på nettet, som er relevante til dine linear applikationer. Her kan de også forsikre dem selv om at vi kun sælger varer af bedste kvalitet. På denne måde kan vi garantere en større indsats i bestillingen og i logistikken.

- Akselføring
- Kuglebøsningsenhed
- Kugleomløbsføring
- Løberulleføring
- Spindelføring

Linear/Aksel: Hærdet/Rustfri stål [SE I WEBSHOP](#)



Obs: Vi kan fremstille i specielle dimensioner

Hærdet aksel	Rustfri aksel	Ø - mål	Kg/M	Længde (mm)
W.04H6-WWL	W.04H8X90-WWL	4 mm	0,10	2100
W.05H6-WWL	W.05H6X90CRMOV18	5 mm	0,16	3200
W.06H6-WWL	W.06H6X90CRMOV18	6 mm	0,23	6000
W.08H6-WWL	W.08H6X90CRMOV18	8 mm	0,40	6000
W.10H6-WWL	W.10H6X90CRMOV	10 mm	0,62	6000
W.12H6-WWL	W.12H6X90CRMOV18	12 mm	0,89	6000
W.13H6-WWL	-	13 mm	1,21	6000
W.14H6-WWL	W.14H6X90CRMOV18	14 mm	1,39	6000
W.15H6-WWL	W.15H6X90CRMOV18	15 mm	1,58	6000
W.16H6-WWL	W.16H6X90CRMOV18	16 mm	2,00	6000
W.18H6-WWL	-	18 mm	2,47	6000
W.20H6-WWL	W.20H6X90CRMOV18	20 mm	2,98	6000
W.24H6-WWL	-	24 mm	3,55	6000
W.25H6-WWL	W.25H6X90CRMOV18	25 mm	3,85	6000
W.28H6-WWL	-	28 mm	4,83	6000
W.30H6-WWL	W.30H6X90CRMOV18	30 mm	5,55	6000
W.32H6-WWL	-	32 mm	6,31	6000
W.35H6-WWL	-	35 mm	7,55	6000
W.40H6-WWL	W.40H6X90CRMOV18	40 mm	9,87	6000
W.45H6-WWL	W.45H6X90CROMOV1	45 mm	12,50	6000
W.50H6-WWL	W.50H6X90CRMOV18	50 mm	15,40	6000
W.55H6-WWL	-	55 mm	18,64	6000
W.60H6-WWL	W.60H6X90CRM018	60 mm	22,20	6000
W.70H6-WWL	-	70 mm	30,20	6000

Tabellen fortsætter på næste side

Hærdet aksel	Rustfri aksel	Ø - mål	Kg/M	Længde (mm)
W.80H6-WWL	-	80 mm	39,50	6000
W.90H6-WWL	-	90 mm	49,92	6000
W.100H6-WWL	-	100 mm	61,62	6000

Hul linear/Aksel: Hærdet stål [SE I WEBSHOP](#)



Obs: Vi kan fremstille i specielle dimensioner

Varenummer	Ø - mål	Indvendig dm	Kg/M	Længde (mm)
WH12	12	4	0,79	3000
WH16	16	7	1,28	3000
WH20	20	14	1,25	3000
WH25	25	15,6	2,35	6000
WH30	30	18,3	3,5	6000
WH40	40	28	4,99	6000
WH50	50	29,7	9,91	6000
WH60	60	36	14,20	6000
WH80	80	57	19,43	6000

Akselbukke

SE I WEBSHOP

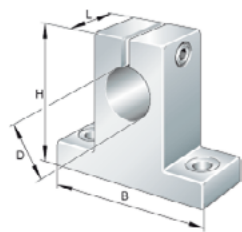

Varenummer	D	H	B	L
GW10	10	30	37	11
GW12	12	35	42	12
GW14	14	38	46	14
GW16	16	42	50	16
GW20	20	50	60	20
GW25	25	58	74	25
GW30	30	68	84	28
GW40	40	86	108	32
GW50	50	100	130	40

KH Linear - Kuglelejer

SE I WEBSHOP

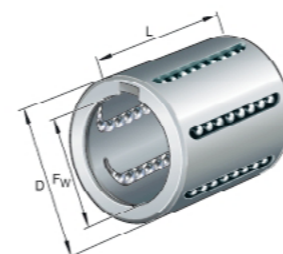

Varenummer Uden tætning	Varenummer Med tætninger	Indvendig FW	Udvendig D	Længde L
KH06	KH06PP	6	12	22
KH08	KH08PP	8	15	24
KH10	KH10PP	10	17	26
KH12	KH12PP	12	19	28
KH14	KH14PP	14	21	28
KH16	KH16PP	16	24	30
KH20	KH20PP	20	28	30
KH25	KH25PP	25	35	40
KH30	KH30PP	30	40	50
KH40	KH40PP	40	52	60
KH50	KH50PP	50	62	70

KGHA Linear - Kuglelejer

SE I WEBSHOP

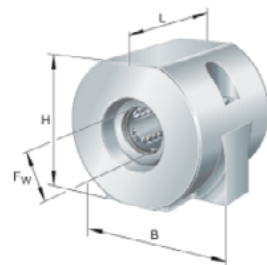

Varenummer	Indvendig Fw	Højde H	Bredde B	Længde L
KGHA10	10	29	29	33
KGHA12	12	39	42	37
KGHA14	14	41	42	37
KGHA16	16	41	42	37
KGHA20	20	48,5	47	39
KGHA25	25	57,5	55	49
KGHA30	30	67,5	65	59
KGHA40	40	84	78	71
KGHA50	50	96	92	81

KGHK Linear - Kuglelejer

SE I WEBSHOP

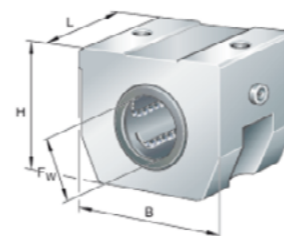

Varenummer	Indvendig Fw	Højde H	Bredde B	Længde L
KGHK06-B-PP-AS	6	27	32	22,2
KGHK08-B-PP-AS	8	27	32	24,2
KGHK10-B-PPAS	10	33	40	26,2
KGHK12-B-PPAS	12	33	40	28,2
KGHK14-B-PPAS	14	36,5	43	28,2
KGHK16-B-PPAS	16	36,5	43	30,2
KGHK20-B-PPAS	20	42,5	53	30,2
KGHK25-B-PPAS	25	52,5	60	40,2
KGHK30-B-PPAS	30	60	67	50,2
KGHK40-B-PPAS	40	73,5	87	60,2

KB, KBS, KBO Linear - Kuglerlejer

SE I WEBSHOP

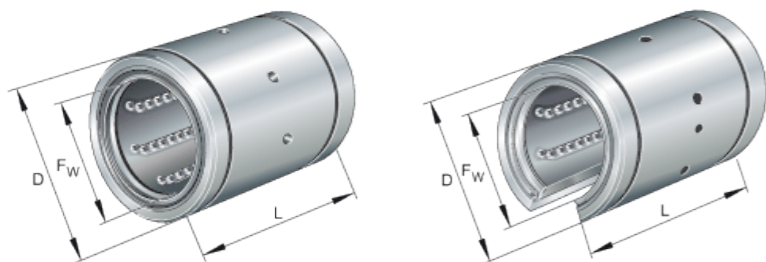

Varenummer (1)	Varenummer (2)	Varenummer (3)	Indvendig FW	Udvendig D	Længde L
KB12 KBS12 KBO12	KB12-PP KBS12-PP KBO12-PP	KB12-PP-AS KBS12-PP-AS KBO12-PPAS	12	22	32
KB16 KBS16 KBO16	KB16-PP KBS16-PP KBO16-PP	KB16-PP-AS KBS16-PP-AS KBO16-PPAS	16	26	36
KB20 KBS20 KBO20	KB20-PP KBS20-PP KBO20-PP	KB20-PP-AS KBS20-PP-AS KBO20-PPAS	20	32	45
KB25 KBS25 KBO25	KB25-PP KBS25-PP KBO25-PP	KB25-PP-AS KBS25-PP-AS KBO25-PPAS	25	40	58
KB30 KBS30 KBO30	KB30-PP KBS30-PP KBO30-PP	KB30-PP-AS KBS30-PP-AS KBO30-PPAS	30	47	68
KB40 KBS40 KBO40	KB40-PP KBS40-PP KBO40-PP	KB40-PP-AS KBS40-PP-AS KBO40-PPAS	40	62	80
KB50 KBS50 KBO50	KB50-PP KBS50-PP KBO50-PP	KB50-PP-AS KBS50-PP-AS KBO50-PPA	50	75	100

- 1) Med konserveringsmiddel.
- 2) Med fedt smøring og tætninger på begge sider.
- 3) Med fedt smøring og tætninger på begge sider, med relubriceringsanlæg.

KN, KNO Linear - Kuglelejer

SE I WEBSHOP

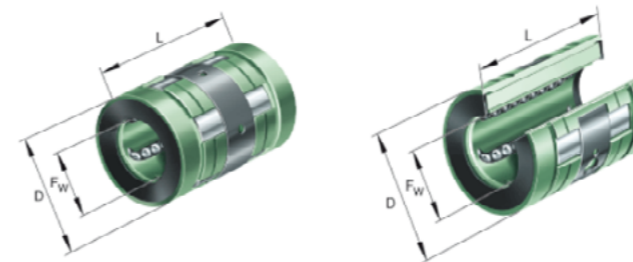

Varenummer (1)	Varenummer (2)	Varenummer (3)	Indvendig FW	Udvendig D	Længde L
KN12-B-PP	KN12-B	KNO12-B-PP	12	22	32
KN16-B-PP	KN16-B	KNO16-B-PP	16	26	36
KN20-B-PP	KN20-B	KNO20-B-PP	20	32	45
KN25-B-PP	KN25-B	KNO25-B-PP	25	40	58
KN30-B-PP	KN30-B	KNO30-B-PP	30	47	68
KN40-B-PP	KN40-B	KNO40-B-PP	40	62	80
KN50-B-PP	KN50-B	KNO50-B-PP	50	75	100

- 1) Med konserveringsmiddel.
- 2) Med fedt smøring og tætninger på begge sider.
- 3) Med fedt smøring og tætninger på begge sider, med relubriceringsanlæg.

KTHK Linear - Kuglelejer

SE I WEBSHOP

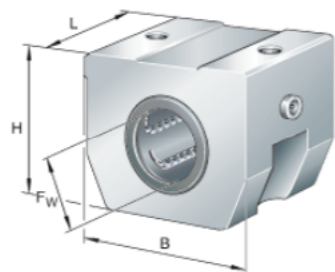

Varenummer	Indvendig Fw	Højde H	Bredde B	Længde L
KTHK12-B-PP-AS	12	33	40	60
KTHK16-B-PP-AS	16	36,5	43	65
KTHK20-B-PP-AS	20	42,5	53	65
KTHK25-B-PP-AS	25	52,5	60	85
KTHK30-B-PP-AS	30	60	67	105
KTHK40-B-PP-AS	40	73,5	87	125
KTHK50-B-PP-AS	50	92	103	145

KTBO Linear - Kuglelejer

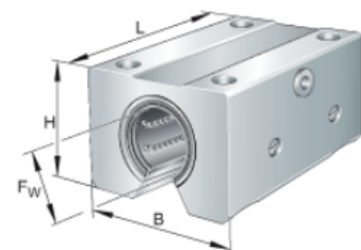

Varenummer	Indvendig Fw	Højde H	Bredde B	Længde L
KTBO12-B-PP-AS	12	30	42	76
KTBO16-B-PP-AS	16	35	50	84
KTBO20-B-PP-AS	20	42	60	104
KTBO25-B-PP-AS	25	51	74	130
KTBO30-B-PP-AS	30	60	84	152
KTBO40-B-PP-AS	40	77	108	176
KTBO50-B-PP-AS	50	88	130	224

KGSNO Linear - Kuglelejer

SE I WEBSHOP

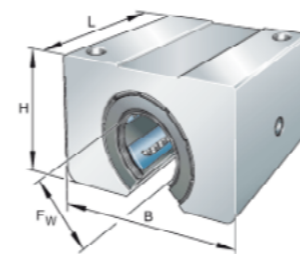

Varenummer	Indvendig Fw	Højde H	Bredde B	Længde L
KGSNO12-B-PPAS	12	28	43	32
KGSNO16-B-PPAS	16	35	53	37
KGSNO20-B-PPAS	20	42	60	45
KGSNO25-B-PPAS	25	51	78	58
KGSNO30-B-PPAS	30	60	87	68
KGSNO40-B-PPAS	40	77	108	80
KGSNO50-B-PPAS	50	88	132	100

KFB Linear - Kuglelejer

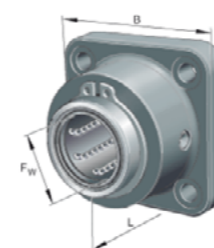

Varenummer	Indvendig Fw	Bredde B	Længde L
KFB12-PP-AS	12	40	32
KFB16-PP-AS	16	50	36
KFB20-PP-AS	20	60	45
KFB25-PP-AS	25	70	58
KFB30-PP-AS	30	80	68
KFB40-PP-AS	40	100	80
KFB50-PP-AS	50	130	100

KGB Linear - Kuglelejer

[SE I WEBSHOP](#)

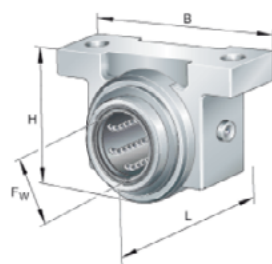

Varenummer	Indvendig Fw	Højde H	Bredde B	Længde L
KGB12-PP-AS	12	35,8	52	32
KGB16-PP-AS	16	37,5	56	36
KGB20-PP-AS	20	47,5	70	45
KGB25-PP-AS	25	57,5	80	58
KGB30-PP-AS	30	66,5	88	68
KGB40-PP-AS	40	83,5	108	80
KGB50-PP-AS	50	98	135	100

KGB0 Linear - Kuglelejer

[SE I WEBSHOP](#)

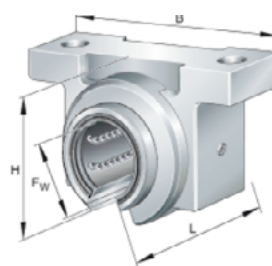

Varenummer	Indvendig Fw	Højde H	Bredde B	Længde L
KGB012-PP-AS	12	32	52	32
KGB016-PP-AS	16	33,5	56	36
KGB020-PP-AS	20	45	70	45
KGB025-PP-AS	25	54,5	80	58
KGB030-PP-AS	30	63,5	88	68
KGB040-PP-AS	40	79,5	108	80
KGB050-PP-AS	50	93	135	100

KGBA Linear - Kuglelejer

[SE I WEBSHOP](#)

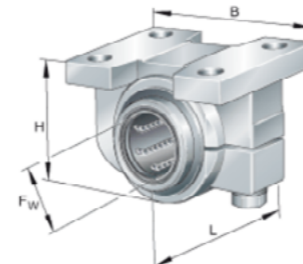

Varenummer	Indvendig Fw	Højde H	Bredde B	Længde L
KGBA12-PP-AS	12	34	42	32
KGBA16-PP-AS	16	41	50	36
KGBA20-PP-AS	20	47,5	60	45
KGBA25-PP-AS	25	60	74	58
KGBA30-PP-AS	30	67	84	68
KGBA40-PP-AS	40	87	108	80
KGBA50-PP-AS	50	98	130	100

KGBA0 Linear - Kuglelejer

[SE I WEBSHOP](#)

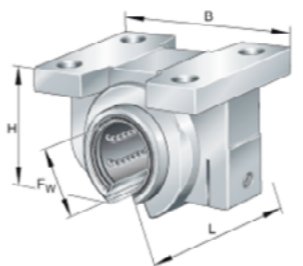

Varenummer	Indvendig Fw	Højde H	Bredde B	Længde L
KGBA012-PP-AS	12	30,5	42	32
KGBA016-PP-AS	16	37	50	36
KGBA020-PP-AS	20	44,5	60	45
KGBA025-PP-AS	25	56	74	58
KGBA030-PP-AS	30	63,5	84	68
KGBA040-PP-AS	40	82,5	108	80
KGBA050-PP-AS	50	93	130	100

Kugleføringsvogne KWE

SE I WEBSHOP

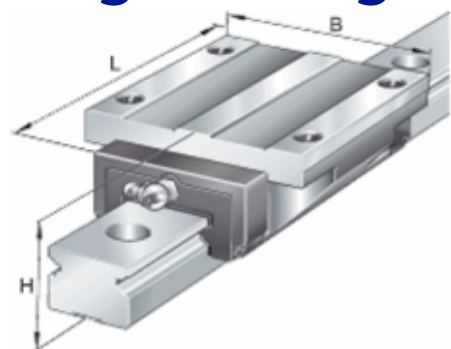

OBS: Udgående type, anvend ikke til nye konstruktioner!
Denne type erstattes af KWVE

Standard model	Høj model	Smal model	Bred model
KWE15	KWE15-H	KWE15-S	KWE15-W
KWE20	KWE20-H	KWE20-S	KWE20-W
KWE25	KWE25-H	KWE25-S	KWE25-W
KWE30	KWE30-H	KWE30-S	KWE30-W
KWE35	KWE35-H	KWE35-S	KWE35-W
KWE40	KWE40-H	KWE40-S	KWE40-W
KWE45	KWE45-H	KWE45-S	KWE45-W

Kugleføringsvogne KWVE

SE I WEBSHOP

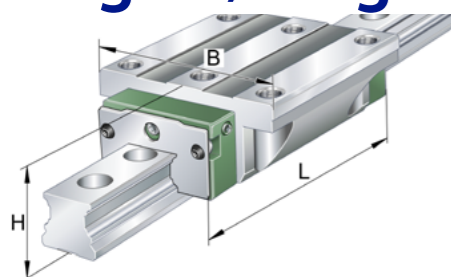

Tilhører KUVE systemet

Standard model	Høj model	Smal model	Bred model
KWVE15 B	KWVE15-B-H	KWVE15-B-S	KWVE15-B-W
KWVE20	KWVE20-H	KWVE20-S	KWVE20-W
KWVE25	KWVE25-H	KWVE25-S	KWVE25-W
KWVE30	KWVE30-H	KWVE30-S	KWVE30-W
KWVE35	KWVE35-H	KWVE35-S	KWVE35-W
KWVE40	KWVE40-H	KWVE40-S	KWVE40-W
KWVE45	KWVE45-H	KWVE45-S	KWVE45-W

Kugleføringsvogne KWEM

SE I WEBSHOP

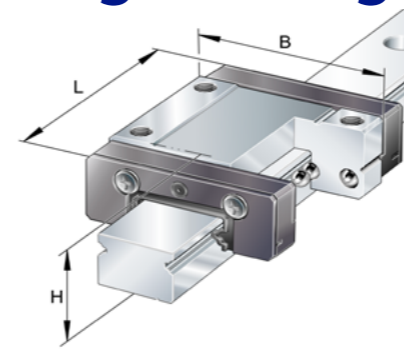

Standard model	Højde H	Bredde B	Længde L
KWEM05	6	12	19
KWEM07	8	17	23,5
KWEM09	10	20	30
KWEM12	13	27	34
KWEM15	16	32	42

Skinnetype LFS

[SE I WEBSHOP](#)

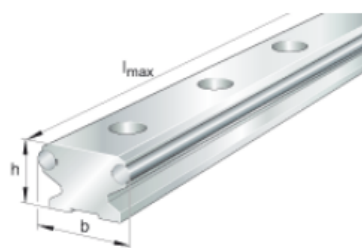

Varenummer	Højde H	Bredde B	Længde L
LFS20	12,2	20	2400
LFS25	15	25	2400
LFS32	20	32	6000
LFS52	34	52	6000
LFS120	25	120	8000

Skinnetype LFS-C

[SE I WEBSHOP](#)

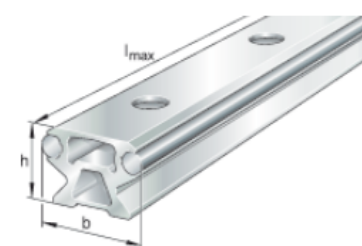

Varenummer	Højde H	Bredde B	Længde L
LFS32-C	20	32	6000
LFS42-C	20	42	6000
LFS52-C	34	52	6000
LFS86-C	34	86	6000

Skinnetype LFS-F

[SE I WEBSHOP](#)

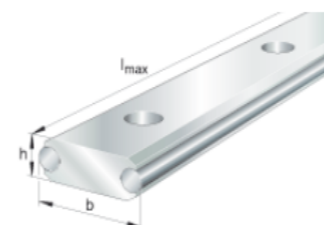

Varenummer	Højde H	Bredde B	Længde L
LFS32-F	10	32	4000
LFS42-F	15	42	4000
LFS52-F	18	52	6000

Skinnetype LFS-M

[SE I WEBSHOP](#)

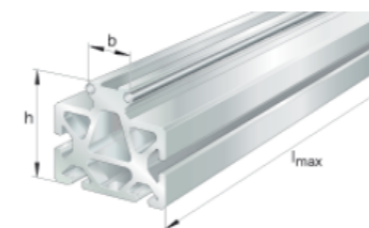

Varenummer	Højde H	Bredde B	Længde L
LFS25-M	46	25	4000
LFS32-M	66,5	32	8000
LFS52-M	98,6	52	8000

Skinnetype TKDM, TKVD, TKSD, TKVD

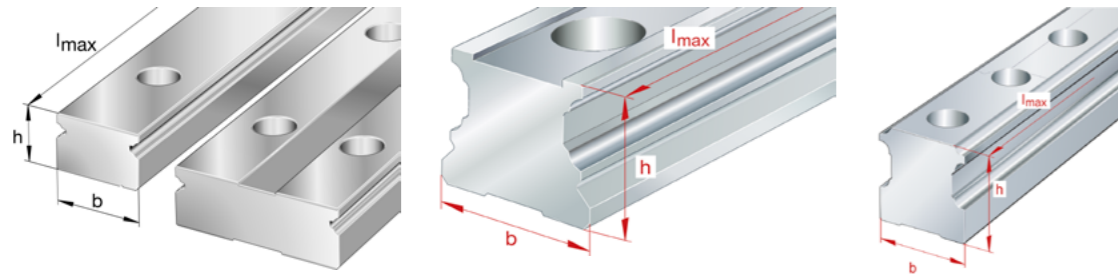

KUME System	KUVE System	KUSE System	KUVE-W System (Bred model)
TKDM05-060	TKVD15B-G3HJ	TKSD-B-15	TKVD15W
TKDM05-090	TKVD20-G3HJ	TKSD-20	TKVD20W
TKDM05-105	TKVD25-G3HJ	TKSD-25	TKVD25W
TKDM05-120	TKVD30-G3HJ	TKSD-30	TKVD35W
TKDM05-150	TKVD35-G3HJ	TKSD-40	TKVD40W
TKDM05-210	TKVD40-G3HJ	TKSD-45	TKVD45W

M **WILHELMSSEN A/s**



Aarhus afdelingen

Åbyvej 69
8230 Åbyhøj
Tlf: +45 86 15 01 11
Email: mw@mw.dk

Vejle afdelingen

Pottemagervej 3
7100 Vejle
Tlf: +45 75 82 02 88
Email: mw@mw.dk

Herlev afdelingen

Mileparken 29
2730 Herlev
Tlf: +45 44 52 13 52
Email: mw@mw.dk