

Typebetegnelsen er fabrikaterne EMB/Ermeto

Lige forskruening
type A/GE

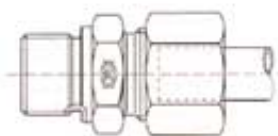

Vinkel forskruening
type B /WE

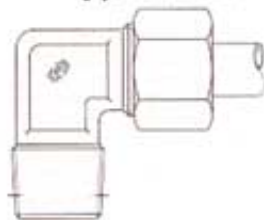

T-stykke
type C/TE

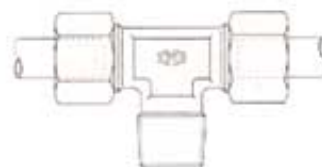

T-stykke
type D/LE

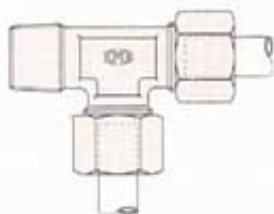

Lige forskruening
type E/G



Reduktion
type ER/KOR

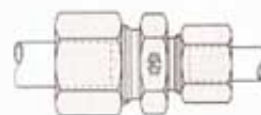

Vinkel-forskrueing
type F/W

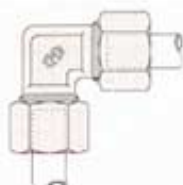

T-stykke
Type G/T



Reduktions T-stykke
type GR/EVT

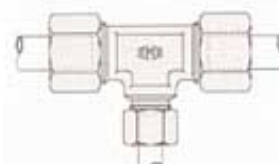

Kryds-forskrueing
type H/K



Lige Skot-forskrueing
type K/SV



Vinkel Skot-forskrueing
type L/WSW

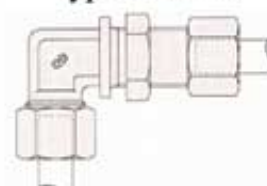

Omløber
type M

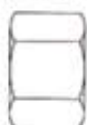

Skærring
type D

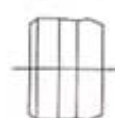

Gevindstuds
1004B



Slangeforskruning
1002B



Vinkelslange-
forskruning
1028B



Slangesamler



Brystnippel
282B



Nippelmuffe
110B



Muffe
103B



Rørprop
109B



Vinkel
116B



T-stykke
Indv.
101B



T-stykke
Udv.
284B



Reduktionsnippel
120B



Vinkelslange-
nippel
1033B



Union
62F



Brystnippel
68F



Vinkelunion
65F



Vinkelnippel
69F



T-stykke
64F



Kuglekontra-
ventil



Nåleventil



Kontramøtrik
1121B



Konusring
60F



Støttebøsning
56F

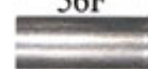

PISTOLER



Industripistol "Heavy Duty"
monteret m. 3/4" slangesnippel

Varenr.: NITO3000A3



Vandings- & spulepistol
m. on/off og vandmængdereg.

Arbejdstryk/temperatur:
Maks. 6 bar ved maks. 40° C.
Maks. 4 bar ved maks. 60° C.

Varenr.: NITO53800A1 - 1/2" koblingsnippel
NITO63820A1 - 3/4" koblingsnippel



STARTERSÆT

Består af:
Et kort basishåndtag
1 slangekobling, 5350SA3
m. slangelås
1 strålerør, 57140A8



Kombigreb on/off i PA/PP
m. kobling

Varenr.: NITO57005A1

Varenr.: NITO57105A8



Basishåndtag m. on/off og
vandmængderegulering samt
1/2" koblingsnippel

Varenr.: NITO57000A1

TILBEHØR

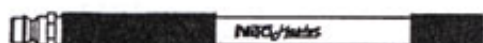

Strålerør

Varenr.: NITO57010A1



Kort strålerør

Varenr.: NITO57140A8

TILBEHØR



Forlængerrør, 55 cm.

Varenr.: NITO57050A1

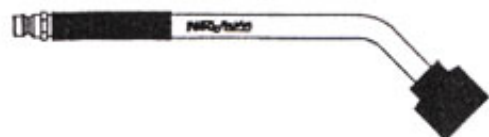

Blomstervander

Varenr.: NITO57020A1



Rodvander

Varenr.: NITO57025A1



Undervognsspuler

Varenr.: NITO57030A1



Vokssprøjte
(incl. 3 voksstifter)

Varenr.: NITO57035A1



Roterende børste
(incl. 8 shampoostifter)

Varenr.: NITO57040A1

Max. temperatur 45 °C.



Håndbørste

Varenr.: NITO57045A1

Max. temperatur 45 °C.



Tværerbørste

Varenr.: NITO57047A1

Max. temperatur 45 °C.





Shampoo til roterende børste
(20 stifter på SB-kort)

Varenr.: NITO57060A1





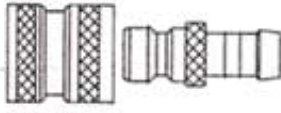
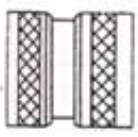
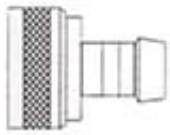
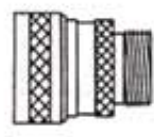
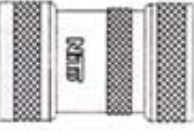
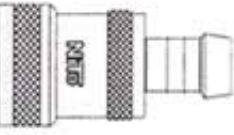

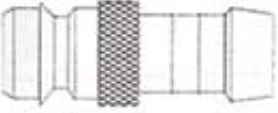
Voks til vokssprøjte
(10 stifter på SB-kort)

Varenr.: NITO57065A1

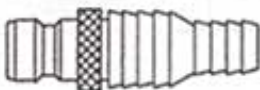
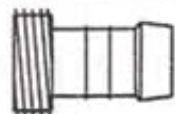
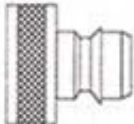

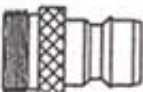

VANDKOBLINGER 1/2" SYSTEM

RG = Rørgvind	Arbejdstryk: Max. 25 bar	Temperatur: Max. 80°
	Koblingssæt m. 1/2" koblingshus og 1/2" slangespids	53506A3
	Koblingssæt m. 1/2" koblingshus, m. indiv. 1/2", 3/4" RG og M22x1 gev. og 1/2" slangespids	535G6A3
	Koblingshus m. indiv. 1/2" RG	53500A3
	Koblingshus m. indiv. 3/4" RG	53520A3
	Koblingshus m. indiv. 1/2", 3/4" RG og M22x1 gevind	5352GA3
	Slangekobling m. 1/2" slangespids	5350SA3
	Slangekobling m. 3/4" slangespids	5351SA3
	Slangekobling m. 3/8" slangespids	5349SA3
	Koblingshus m. udv. 1/2" RG	5350NA3
	Koblingshus m. udv. 3/4" RG	5352NA3
	Koblingshus m. udv. 1/2" RG samt stopventil	5353NA3
	Koblingshus m. indiv. 3/4" RG samt stopventil	53530A3
	Koblingshus m. indiv. 1/2", 3/4" RG og M22x1 gev. samt stopventil	5353GA3
	Koblingshus m. indiv. 1/2", 3/4" RG samt stopventil	5353RA3
	Koblingshus m. 1/2" slangespids og stopventil	5353SA3
	Koblingshus m. 3/4" slangespids og stopventil	5354SA3
NB! Leveres kun på kort.		
	1/2" samlesæt m. 1/2" slange-spids og låse.	5360SA1
	Slangenippel m. 1/2" slangespids	53600A3
	Slangenippel m. 3/8" slangespids	5360BA3
	Slangenippel m. 5/8" slangespids	5360CA3
	Slangenippel m. 1/4" slangespids	5360DA3



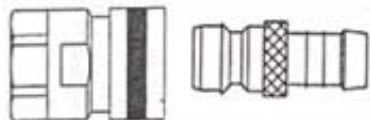
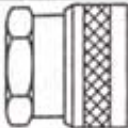

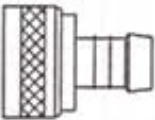
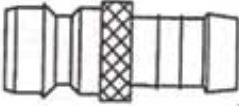
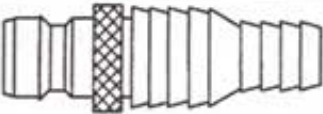
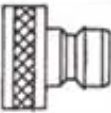
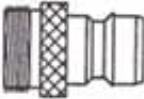
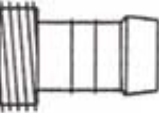

VANDKOBLINGER 1/2" SYSTEM

RG = Rørgvind	Arbejdstryk: Max. 25 bar	Temperatur: Max. 80°
	1/2" koblingsled, monteres mellem 2 slangekoblinger	53650A3
	Slangenippel m. dobbelt slangespids til 3/4" og 1/2" slange	5360AA3
	Slangerør m. udv. 1/2" RG og 1/2" slangespids	53670A3
	Koblingsnippel m. indv. 1/2" RG	53610A3
	Koblingsnippel m. indv. 3/4" RG	5361AA3
	Koblingsnippel m. gev.ring indv. 1/2", 3/4" RG og M22x1 gev.	5361GA3
	Koblingsnippel m. indv. M22x1 gev.	53620A3
	Selvskaerende koblingsnippel. Overgang fra plastværktøj, eks. havevander, autobørster el. lign. til NITO-systemet.	5361XA3
	Koblingsnippel m. udv. 1/2" RG	53640A3
	Koblingsnippel m. udv. 3/4" RG	5364AA3
	Koblingsnippel m. udv. 3/8" RG	5364BA3
	Nippel, 1/2" for pistol	53611A3
	1/2" koblingsnippel m. 3/4" RG	53615A3
	Indstilleligt strålerør til 1/2 slangekobling.	53750A3
	Fordelerled m. 1/2" koblingsnipler	53760A3
	Fordelerled m. 1/2" koblingsnippel og to 1/2" RG	53761A3

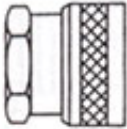
VANDKOBLINGER 3/4" SYSTEM

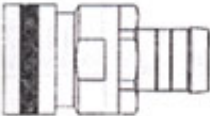

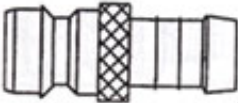
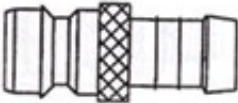
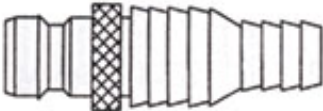

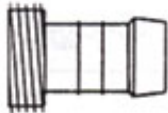



RG = Rørgvind	Arbejdstryk: Max. 25 bar	Temperatur: Max. 80°
	Koblingssæt m. 3/4" koblingshus og koblingsnippel m. 3/4" slangespids	63506A3
	Koblingshus m. indiv. 3/4" RG	63500A3
	Ventilkoblingshus m. indiv. 3/4" RG og stopventil	63530A3
	Ventilkoblingshus m. 3/4" slangespids og stopventil	6353SA3
	Koblingshus m. 3/4" slangespids	6350SA3
	Koblingsnippel m. 3/4" slangespids	63600A3
	Koblingsnippel m. 1/2" slangespids	6360BA3
	Koblingsnippel m. 5/8" slangespids	6360CA3
	Koblingsnippel m. dobbelt slangespids til 1" og 3/4" slange	6360AA3
	Koblingsnippel m. indiv. 3/4" RG	63610A3
	Koblingsnippel m. indiv. 1/2" RG	6361AA3
	Koblingsnippel m. udv. 3/4" RG	63640A3
	Koblingsnippel m. udv. 1/2" RG	6364AA3
	Slangerør m. udv. 3/4" RG og 3/4" slangespids	63670A3
	Slangerør m. udv. 3/4" RG og 1/2" slangespids	6367AA3
	Indstilleligt strålerør til 3/4" slangekobling	63750A3

VANDKOBLINGER 1" SYSTEM

RG = Rørgvind	Arbejdstryk: Max. 25 bar	Temperatur: Max. 80°
	Koblingshus m. indv. 1" RG	73500A3
	Ventilkoblingshus m. indv. 1" RG og stopventil	73530A3
	Ventilkoblingshus m. 1" slangespids og stopventil	7353SA3
	Blændprop	7350ZA3
	Koblingsnippel m. 1" slangespids	73600A3
	Koblingsnippel m. 3/4" slangespids	7360BA3
	Koblingsnippel m. dobbelt slangespids til 1 1/4" og 1" slange	7360AA3
	Koblingsnippel m. indv. 1" RG	73610A3
	Koblingsnippel m. udv. 1" RG	73640A3
	Slangerør m. udv. 1" RG og 1" slangespids	73670A3

OVERGANGE OG STÅLERØR

RG = Rørgvind

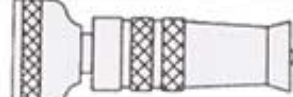
	<p>Overgangsstykke m. udv. 1/2" RG og indv. 3/4" RG</p> <p>Overgangsstykke m. udv. 1/2" RG og indv. M22x1 gev.</p> <p>Overgangsstykke m. udv. 3/4" RG og indv. M22x1 gev.</p>	<p>53690A3</p> <p>53700A3</p> <p>53720A3</p>
	<p>Overgangsstykke m. udv. 3/4" RG og indv. 1" RG</p>	<p>63690A3</p>
	<p>Overgangsstykke m. udv. M22x1 gev. og indv. 1/2" RG</p>	<p>5369BA3</p>
	<p>Overgangsstykke m. udv. 3/4" RG og indv. 1/2" RG</p>	<p>5371AA3</p>
	<p>Overgangsstykke m. udv. 1/2" RG og udv. M24x1 gev.</p> <p>Overgangsstykke m. udv. M22x1 gev. og udv. M24x1 gev.</p>	<p>53730A3</p> <p>53740A3</p>
	<p>Overgangsstykke m. udv. M18x1 gev. og udv. M22x1 gev.</p>	<p>5369DA3</p>
	<p>Reduktionsring m. udv. 1/2" RG og indv. 3/8" RG</p> <p>Reduktionsring m. udv. 3/4" RG og indv. 1/2" RG</p>	<p>5349BA8</p> <p>53490A8</p>
	<p>Gevindring m. udv. 3/4" RG og indv. 1/2" RG/M22x1 gev.</p>	<p>53480A8</p>
	<p>1/2" rå indstilleligt strålerør til 15 mm + 20 mm slange</p>	<p>20000A4</p>
	<p>3/4" fornilet indstilleligt strålerør m. 3/4" indv. RG</p>	<p>20300A9</p>

SLANGEKOBLING MED LANG HALS

Storz slangekobling anvendes primært som brandkobling og til transport af væsker, luft, pulver og granulat.

Alle koblinger er forsynet med sug- og trykpakning i nitril (sort). Andre pakningskvaliteter kan leveres.

Slangekoblingerne lagerføres i letmetal (L)

Arbejdstryk:

Storz D/1" til 125/5" max. 16 bar

Storz 150/6" til 250/10" max. 10 bar

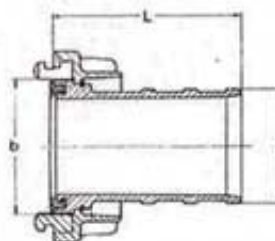

➔ **Storz 150/6" er forsynet med 3 kløer**
Storz 250/10" er forsynet med 3 kløer og koblingshåndtag

Storz type	For Ø Slange	b	D	L
D/1"	25 mm	31,0	25,0	53,0
D/1"	19 mm	31,0	19,0	50,0
D/1"	13 mm	31,0	13,0	50,0
C/2"	52 mm	66,0	52,0	90,0
C/2"	38 mm	66,0	38,0	90,0
C/2"	32 mm	66,0	32,0	90,0
C/2"	32 mm	66,0	32,0	95,0
C/2"	25 mm	66,0	25,0	90,0
C/2"	19 mm	66,0	19,0	90,0
B/3"	75 mm	89,0	75,0	125,0
B/3"	65 mm	89,0	65,0	125,0
A/4"	102 mm	115,0	101,0	150,0
110 mm	110 mm	133,0	110,0	170,0
110 mm	100 mm	133,0	100,0	170,0
110 mm	90 mm	133,0	90,0	170,0
125/5"	125 mm	148,0	125,0	196,0
150/6"	150 mm	160,0	150,0	180,0
205/8"	205 mm	220,0	205,0	375,0
250/10"	250 mm	278,0	250,0	400,0

FASTKOBLING MED INDV. RØRGEVIND

Storz fastkobling anvendes primært som brandkobling og til transport af vædsker, luft, pulver og granulat.

Fastkoblinger type C/2" til A/4" er forsynet med trykpakning i nitril (sort), type D/1" og 110 mm til 250/10" er forsynet med sug- og trykpakning. Andre pakningskvaliteter kan leveres.

De med * markerede varenumre er fastkoblinger med metallisk pakflade.

Arbejdstryk:

Storz D/1" til 125/5" max. 16 bar
Storz 150/6" til 250/10" max. 10 bar

➔ **Storz 150/6" og 250/10"** er forsynet med 3 kløer

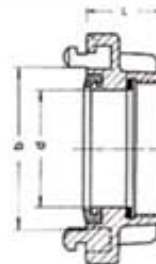

Storz type	BSP gevind	b	d	L
D/1"	1/2"	31,0	18,0	30,0
D/1"	3/4"	31,0	18,0	30,0
D/1"	1"	31,0	18,0	30,0
C/2"	1"	66,0	25,0	36,0
C/2"	1 1/4"	66,0	32,0	32,0
C/2"	1 1/2"	66,0	40,0	32,0
C/2" *	1 1/2"	66,0	45,0	32,0
C/2"	2"	66,0	44,5	40,0
C/2" *	2"	66,0	50,0	40,0
C/2"	2 1/2"	66,0	44,5	37,0
B/3"	2"	89,0	50,0	38,0
B/3"	2 1/2"	89,0	64,5	40,0
B/3"	3"	89,0	64,5	39,0
B/3" *	3"	89,0	64,5	40,0
A/4"	3 1/2"	115,0	89,5	47,0
A/4"	4"	115,0	89,5	45,0
110 mm	4"	133,0	100,0	48,0
110 mm	4 1/2"	133,0	100,0	45,0
125/5"	5"	148,0	115,0	52,0
150/6"	6"	160,0	130,0	96,0
205/8"	8"	220,0	186,0	75,0
250/10"	10"	278,0	236,0	78,0

FASTKOBLING MED UDV. RØRGEIND

Storz fastkobling anvendes primært som brandkobling og til transport af væsker, luft, pulver og granulat.

Fastkobling type D/1" er forsynet med sug- og trykpakning i nitril (sort), type C/2" og A/4" er forsynet med trykpakning. Andre pakningskvaliteter kan leveres.

De med * markerede varenumre er fastkoblinger med metallisk pakflade.



Arbejdstryk:

Storz D/1" til A/4" max. 16 bar

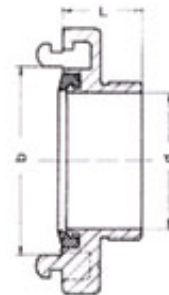

Storz type	BSP gevind	b	d	L
D/1"	3/4"	31,0	18,0	30,0
D/1"	1"	31,0	18,0	30,0
C/2"	1"	66,0	22,0	36,0
C/2"	1 1/4"	66,0	30,0	36,0
C/2"	1 1/2"	66,0	38,0	32,0
C/2" *	1 1/2"	66,0	38,0	32,0
C/2"	2"	66,0	45,0	32,0
C/2" *	2"	66,0	46,0	32,0
B/3"	2 1/2"	89,0	65,0	38,0
B/3"	3"	89,0	60,0	40,0
B/3" *	3"	89,0	64,5	40,0
B/3"	3"	89,0	65,0	38,0
A/4" *	4"	115,0	100,0	47,0

FASTKOBLINGER MED DREJELIG RING OG INDV.- OG UDV. RØRGEVIND

Storz fastkobling anvendes primært som brandkobling og til transport af væsker, luft, pulver og granulat.

Fastkoblinger er forsynet med trykpakning i nitril (sort), Andre pakningskvaliteter kan leveres.

Arbejdstryk:

Storz C/2" til B/3" max. 16 bar

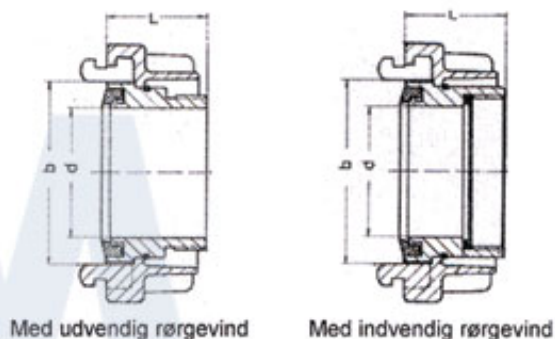
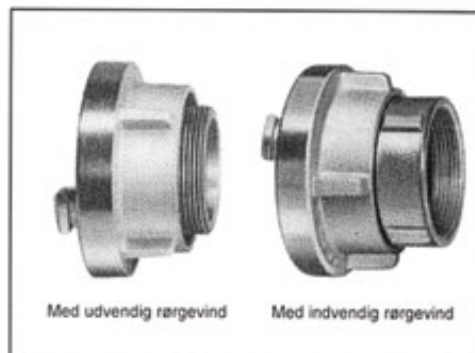

Med udvendig rørgvind

Storz type	Udv. BSP gevind	b	d	L
C/2"	1 1/2"	66,0	45,0	45,0
C/2"	2"	66,0	45,0	68,0

Med indvendig rørgvind

Storz type	Indv. BSP gevind	b	d	L
C/2"	2"	66,0	44,5	68,0
B/3"	2 1/2"	89,0	65,0	49,0
B/3"	3"	89,0	65,0	80,0

OVERGANGSSTYKKE

Storz overgangsstykke anvendes primært som brandkobling og til transport af vædske, luft, pulver og granulat.

Overgangsstykke er forsynet med trykpakning i nitril (sort). Andre pakningskvaliteter kan leveres.

Arbejdstryk:

Storz C/2" x D/1" til
150/6" x 125/5" mm

max. 16 bar



Storz 150/6" og 250/10" er forsynet med 3 kløer

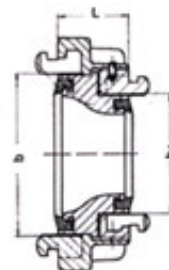

Storz type	b/b1	L
C/2" x D/1"	66,0/31,0	33,0
C/2" x D/1"	66,0/31,0	52,0
B/3" x C/2"	89,0/66,0	39,0
A/4" x B/3"	115,0/89,0	45,0
110mm x B/3"	133,0/89,0	50,0
110mm x A/4"	133,0/115,0	68,0
150/6" x 125/5"	160,0/148,0	154,0
150/6" x 110mm	160,0/133,0	84,0

SLUTDÆKSEL

Storz slutdæksel anvendes primært til beskyttelse mod snavs, støv- og vandudsivning på rør hvor storz fastkoblinger er monteret.

Slutdæksler er forsynet med sug- og trykpakning i nitril (sort). Andre pakningskvaliteter kan leveres.

Arbejdstryk:

Storz D/1" til 125/5" max. 16 bar
Storz 150/6" til 250/10" max. 10 bar

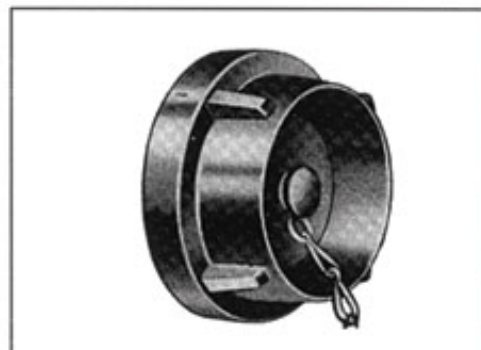

➔ **Storz 150/6" og 250/10"** er forsynet med 3 kløer

Storz type	b	L
D/1"	31,0	28,0
C/2"	66,0	43,0
B/3"	89,0	45,0
A/4"	115,0	47,0
110 mm	133,0	48,0
125/5"	148,0	52,0
150/6"	160,0	56,0
205/8"	220,0	75,0
250/10"	278,0	78,0

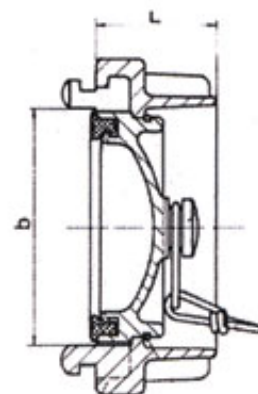

Storz koblinger lagerføres i letmetal, men kan skaffes i metal og i visse udførsler i syrefast rustfri stål.

KAMKOBLINGER

Arbejdstryk i bar for kamkoblinger i forskellige materialer.

Materiale	Dimension i tommer					
	1/2"	3/4"-2"	2 1/2"	3"	4"	5-6"
Aluminium	10	17	10	8	7	5
Bronze	10	17	10	8	7	5
Rustfrit Stål	10	17	15	14	7	7
Polypropylen	5	7	-	4	4	-



Kamkoblinger er ensbetydende med hurtig og sikker sammenkobling af slanger og rør for lang række væsker og faste medier. Anvendelsesområdet dækker bl.a. olie, benzin, kemikalier, maling, vand, mel, fødevarer og mange andre.

Kamkoblingen laves i 4 forskellige materialer - aluminium, bronze, rustfrit stål og polypropylen.

Kamkoblinger laves med følgende gevindstørrelser (dog visse undtaget): 1/2", 3/4", 1", 1 1/4", 1 1/2", 2", 2 1/2", 3", 4", 5" og 6".

Kamkoblinger passer til følgende slangediameter:

13mm, 19mm, 25mm, 32mm, 38mm, 51mm, 64mm, 76mm, 102mm, 127mm og 152mm.



Hankobling med udv. gevind



Hankobling med slangestuts



Hankobling med indv. gevind



Slutprop for hankobling



Hankobling med udvendigt gevind



Hankobling med slangestuts



Hankobling med indv. gevind



Slutdæksel for hankobling

KLOKOBLINGER



Slangestuds for 6, 10,
13, 16, 19, 25 og 32mm



Indv. gevind 1/4",
3/8", 1/2", 3/4" og 1"



Udv. gevind 1/4",
3/8", 1/2", 3/4" og 1"

Klo-koblingen er trykluftskoblinger for lave og middelhøje tryk (arbejdstryk 10 bar).
Låsedelen har dobbelte låsekæber, som har samme størrelse uanset størrelsen på koblingen.



LUFT KOBLINGER



Luft koblingerne lagerføres med 1/4", 3/8" og 1/2" slangestuds, indv. og udv. gevind.

Koblinger



Udvendig gevind

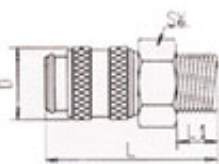

1/4"
3/8" udv. gevind
1/2"

Koblingsnipler



Slangestuds

1/4"
3/8" slangestuds
1/2"



Indvendig gevind

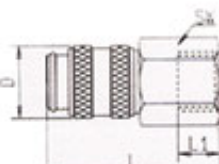

1/4"
3/8" indv. gevind
1/2"



Udvendig gevind

1/4"
3/8" udv. gevind
1/2"



Slangestuds

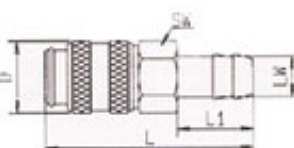

1/4"
3/8" slangestuds
1/2"



Indvendig gevind

1/4"
3/8" indv. gevind
1/2"

Luftkoblinger kan fås så de er kompatible med Cejn, JVL, Rectus, TEMA, Alas copco, Hansen og mange andre.

BLÆSEPISTOLER



Alm. blæsepistol
får i flere udgaver



Blæsepistol m/
stjerne dyse



Blæsepistol m/6mm
bøjet forniklet rør



Blæsepistol m/
bypass dyse



Blæsepistol m/
1/8" indiv. rørgæv.



Blæsepistol m/M12x1,25
indv. rørgvind

VANDUDSKILLER OG REGULATOR



Regulator



Vandudskiller



Flangesæt

Lyn-fittings lagerføres i størrelserne fra $\varnothing 5\text{mm}$ til $\varnothing 14\text{mm}$ slange.

Lige unioner m. indv. gevind



Lige unioner m. udv. gevind



Drejelige vinkler



Baser



Dobbeltunioner



T-stykker

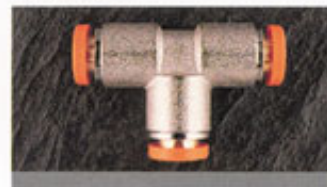

Vinkler



Vinkler, drejelige



Kontra/drovventiler



Reduktionsventiler



FITTINGS



Vi lagerfører disse typer af polyamid fittings, i alle størrelser:



Samler



T-stykke



Vinkel



Hane



Vinkel-forskrueing

SLANGEOPRULLERE

Slangeoprullere til luft, vand og el.



AUTOMATISKE SLANGEOPRULLERE TIL LUFT OG VAND

- Velegnet til industri, landbrug, værksteder og m.fl.
- Epoxy pulverlakeret overfladebehandling
- Styrearm m. 4 retningsruller indstillig i 9 forskellige pos.
- Multi-positions palsysem
- Lækfri swivel med fuld gennemstrømning
- Total indelukket og vedligeholdelsesfri fjeder
- Smidig gummislange - max. temp. 100gr
- Mulighed for væg, loft eller gulvmontering



Model 809
1/4" og 3/8"
165mm l-formet stålstel



Model 808
3/8" og 1/2"
175mm L-formet stålstel



Model 820
3/8" og 1/2"
dobbeltarmet



Model 809
rustfri
3/8"



Model 808
rustfri
3/8" og 1/2"



Model 820
rustfri
3/8" og 1/2"



- Total lukket model
- Epoxy pulverlakeret stålbox
- Udvendige styrehuller justerbare for væg, loft eller gulvmontering
- Smidig gummislange - max temp. 100gr.
- Fås med slange i størrelserne 1/4", 3/8" og 1/2"

SLANGEOPRULLERE



Automatisk slangeopruller
i slagfast plast til trykluft.
Max 12 BAR



Slangetromle i slagfast
plast til trykluft.
Max 15 BAR



Automatisk slangeopruller
i slagfast plast til el.
230v eller 400v



Universal håndbetjent
slangeopruller.
Max 16BAR



Håndbetjent slangeopruller
Leveres uden slange



Slangetromlevogn
Leveres uden slange



Slangeholder - glansdorzinkede

SPÆNDEBÅND

ABA Original

Båndbredde 12 mm



● Syrefast



● Kulstofstål

Tilspændingsområde

mm		mm	
8—	14	68—	85
11—	17	77—	95
13—	20	87—	112
15—	24	104—	138
19—	28	130—	165
22—	32	150—	180
26—	38	175—	205
32—	44	200—	231
38—	50	226—	256
44—	56	251—	282
50—	65	277—	307
58—	75		

ABA Gummiklemmer



Tilspændingsområde

mm	mm	mm
3.2	20.6	38.1
4.8	22.2	42.0
6.4	23.8	44.5
7.9	25.4	48.0
9.5	27.0	50.8
11.1	28.6	55.0
12.7	30.2	60.0
14.3	31.8	64.0
15.9	33.3	75.0
17.5	34.9	110.0
19.0	36.5	

ABA Mini



Båndbredde 9 mm

Betegn.

mm

8

9

10

11

12

13

14

15

16

17

ABA Sortiment



Dimension: 40 x 8,5 x 27 cm

ABA NOVA Original	Antal
8—14 (15)	50
11—17 (17)	50
13—20 (22)	50
15—24	25
19—28	25
22—32	20
26—38	15
32—44	15
38—50	10
44—56	10
	<u>270</u>

1 ABA skruetrækker 25 cm

ABA Mini Sortiment



Dimension: 27 x 4 x 15 cm

ABA Mini	Antal
8	15
9	15
10	30
11	10
12	30
13	10
14	5
15	5
	<u>120</u>

ABA skruetrækker



1 ABA skruetrækker
25 cm

ABA multispændebånd

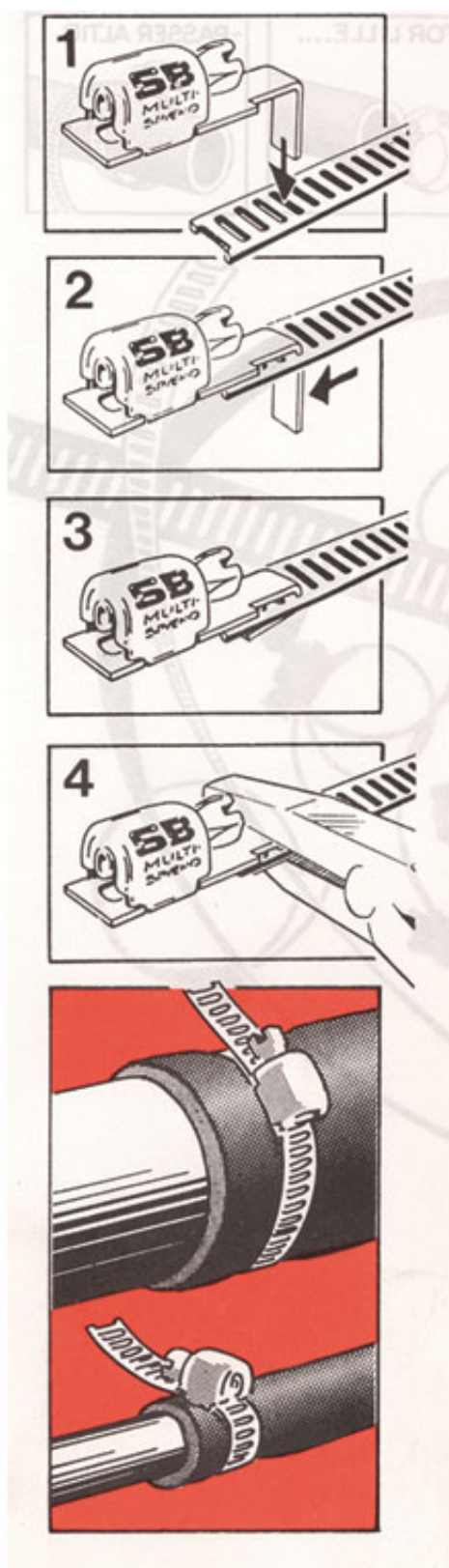

SB multibånd er med bånd og låsehus i rustfrit stål.
Båndet ligger i kasser a 5mtr.
og låsene 25 stk.



OETIKER SPÆNDEBÅND

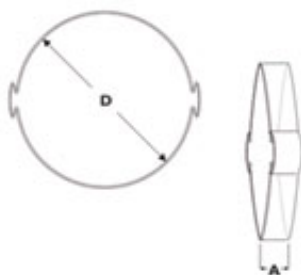

D (mm)		A (mm)	
min.	max.	bredden/ width	stk./pcs
5	7	6,0	100
7	9	7,0	100
9	11	7,0	100
11	13	7,0	100
13	15	7,5	100
14	17	7,5	100
15	18	7,5	100
17	20	7,5	100
18	21	9,0	100
20	23	9,0	100
22	25	9,0	100
23	27	9,0	100
25	28	9,0	100
28	31	9,5	100
31	34	9,5	100
34	37	9,5	100
37	40	10,0	100
40	43	10,0	75
43	46	10,0	75



Oetiker-spændebåndet klemmes med tang - og kan derfor kun bruges en gang.

PATENTBÅND



Patentbåndet ganske simpelt:

- Den nødvendige længde afkortes med tang.
- Båndet formes omkring røret, med hænderne eller tangen
- Det spændes sammen med 1/4" skrue.

Patentbåndet ligger i forpakninger a 25mtr.

POWER-CLAMPS I ALM. OG RUSTFRI UDFØRSEL



POWER-CLAMP NR.	DIAMETER MM	POWER-CLAMP NR.	DIAMETER MM
35	30-35	115	110-115
40	35-40	120	110-120
45	40-45	125	120-125
50	40-50	130	125-130
55	45-55	135	130-135
60	50-60	140	130-140
65	55-65	150	140-150
70	60-70	160	150-160
75	65-75	170	160-170
80	70-80	180	170-180
85	75-85	190	180-190
90	80-90	200	190-200
100	90-100	210	200-210
110	100-110	220	210-220

Power-clamp spændebåndet har en meget stærk konstruktion, fremstillet helt i stål (eller rustfri) med 1 eller 2 unbrakoskruer. Bredden på båndene variere fra 20mm til 25mm.

TO-BOLTS SPÆNDEBÅNDET



To-bolts spændebåndet er meget anvendeligt da det sikre fuld greb omkring slangen. Spændebåndet kan anvendes til tryklufapplikationer både sug og tryk.

Diameter mm
17-22
22-29
28-34
32-40
39-49
48-60
60-76
77-94
89-101
103-113
113-127
127-140
140-154
155-175
175-195
195-208
210-225

RØRCLAMPS



Rørclamps med 8mm bøjle.

Ø MM	Ø TOMME
25	1"
29	1 1/8"
32	1 1/4"
35	1 3/8"
38	1 1/2"
41	1 5/8"
44	1 3/4"
48	1 7/8"
51	2"
54	2 1/8"
57	2 1/4"
60	2 3/8"
63	2 1/2"
66	2 5/8"
70	2 3/4"
73	2 7/8"
76	3"
83	3 1/4"
89	3 1/2"
95	3 3/4"
102	4"

BAND-IT BÅND & LÅSE



BAND-IT båndet og låsene har vi på lager i rustfri udførsel i størrelserne 1/4", 3/8" og 1/2", desuden kan der på forespørgsel leveres alle typer af bånd, låse og spændebånd i BAND-IT typen.