

På de forestående sider viser vi et lille udpluk af vores lejeprogram - såfremt de skulle ønske mere information er de velkommen til at rekvirere yderligere materiale.

KUGLELEJER

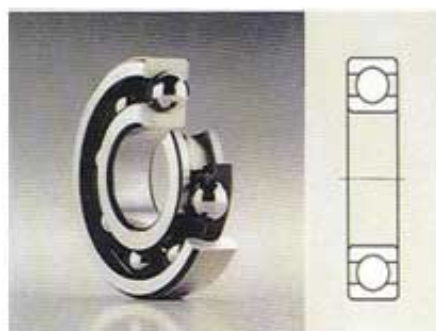

Sporkugleleje
enradet

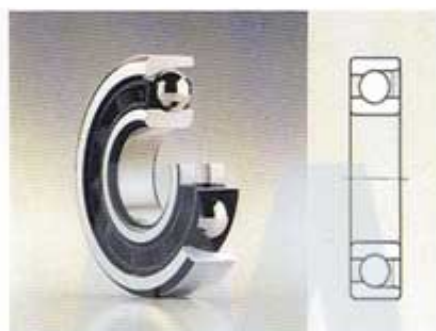

Magnetkugleleje

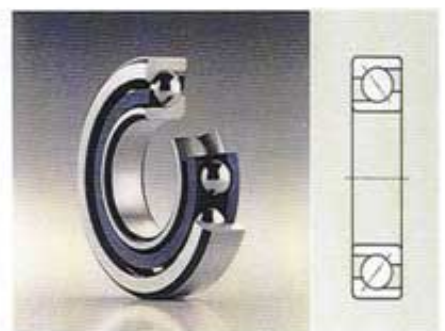

Vinkelkontaktkugleleje
enradet

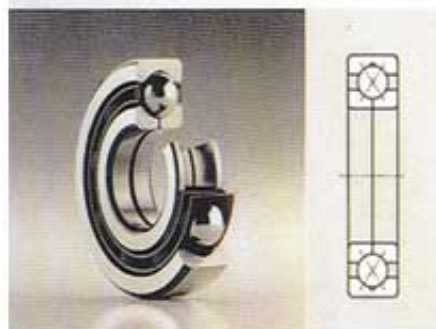

Firepunktsleje

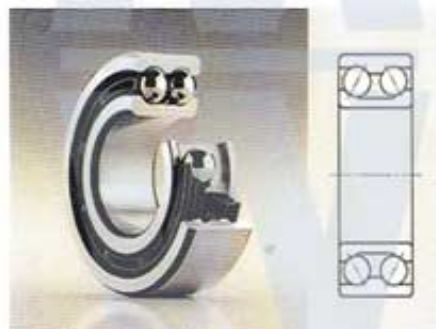

Vinkelkontaktkugleleje
toradet

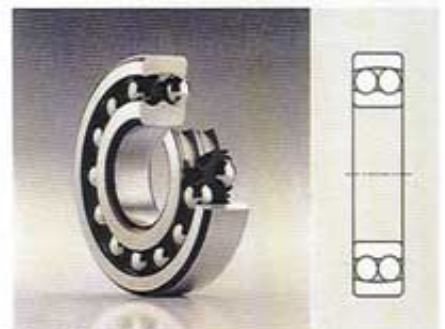

Sfærisk kugleleje



Aksialkugleleje
enkeltvirkende

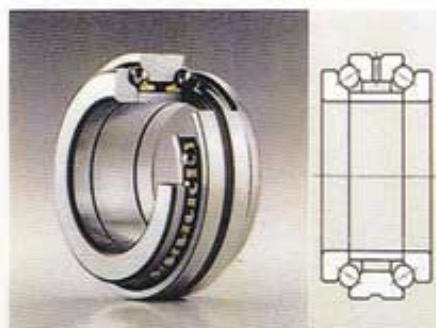

Aksial-vinkelkontaktkugleleje
dobbeltvirkende



Aksialkugleleje
dobbeltvirkende

Af de viste kugle- og rullelejer har vi et stort lager og såfremt De har nogle konkrete forespørgsler både på FAG lejer og andre fabrikater er De velkommen til at kontakte os.

RULLELEJER



Cylindrisk rulleleje
tørådet



Cylindrisk rulleleje
tørådet



Cylindrisk rulleleje
tørådet, fuldtrådet



Konisk rulleleje



Enradet sfærisk rulleleje



Tørådet sfærisk rulleleje E



Sfærisk rulleleje
dybt



Cylindrisk aksialrulleleje

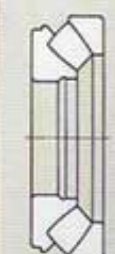

Sfærisk aksialrulleleje

FAG's program af støbejernshuse

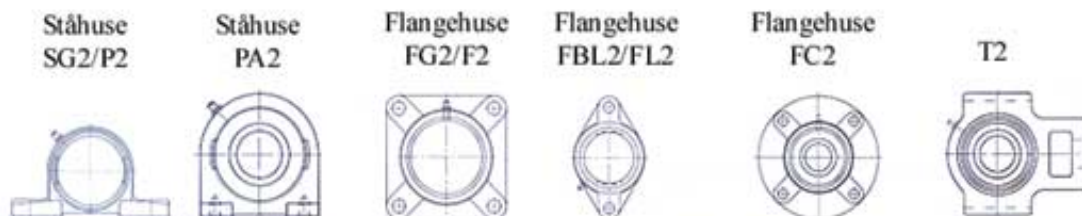

162...	P162	PA162	F162	FL162	FC162	T162
d = 12...60 mm d = 1/2...2 7/16 in	d = 12...60 mm d = 1/2...2 7/16 in	d = 20...60 mm d = 3/4...2 7/16 in	d = 12...60 mm d = 1/2...2 7/16 in	d = 12...60 mm d = 1/2...2 7/16 in	d = 20...60 mm d = 3/4...2 7/16 in	d = 20...60 mm d = 3/4...2 7/16 in



362...	P362	PA362	F362	FL362	FC362	T362
d = 20...90 mm d = 3/4... 3 1/2 in	d = 20...90 mm d = 3/4... 3 1/2 in	d = 20...60 mm d = 3/4...2 7/16 in	d = 20...90 mm d = 3/4... 3 1/2 in	d = 20...75 mm d = 3/4...3 in	d = 20...90 mm d = 3/4... 3 1/2 in	d = 20...90 mm d = 3/4... 3 1/2 in



562...	P562	PA562	F562	FL562	FC562	T562
d = 20...90 mm d = 3/4... 3 1/2 in	d = 20...90 mm d = 3/4... 3 1/2 in	d = 20...60 mm d = 3/4...2 7/16 in	d = 20...90 mm d = 3/4... 3 1/2 in	d = 20...75 mm d = 3/4...3 in	d = 20...90 mm d = 3/4... 3 1/2 in	d = 20...90 mm d = 3/4... 3 1/2 in









762...2rsr	P762.2RSR	PA762.2RSR	F762.2RSR	FL762.2RSR	FC762.2RSR	T762.2RSR
d = 17...60 mm	d = 17...60 mm	d = 20...60 mm	d = 17...60 mm	d = 17...60 mm	d = 20...60 mm	d = 20...60 mm



Udover FAG's program, som tilstedelighed bliver udbygget, har vi andre fabrikater at tilbyde.

FAG's program af blik-huse

	Ståhuse SB2	Flangelejhuse FB2	Flangelejhuse FBB2
Spænderingslejer			
162...	til kombination med 162...		
d = 12...50 mm	d = 12...35 mm	d = 12...50 mm	d = 12...35 mm
d = 1/2...1 ¹⁵ / ₁₆ in	d = 1/2...1 ⁷ / ₁₆ in	d = 1/2...1 ¹⁵ / ₁₆ in	d = 1/2...1 ⁷ / ₁₆ in
			
362...		til kombination med 362...	
d = 20...50 mm		d = 20...50 mm	d = 20...35 mm
d = 3/4...1 ¹⁵ / ₁₆ in		d = 3/4...1 ¹⁵ / ₁₆ in	d = 3/4...1 ⁷ / ₁₆ in
			
562...		til kombination med 562...	
d = 20...50 mm		d = 20...50 mm	d = 20...35 mm
d = 3/4...1 ¹⁵ / ₁₆ in		d = 3/4...1 ¹⁵ / ₁₆ in	d = 3/4...1 ⁷ / ₁₆ in
			
762...2rsr	til kombination med 762...2rsr		
d = 17...50 mm	d = 17...35 mm	d = 17...50 mm	d = 17...35 mm
			

FAG's todelte ståhuse SNV

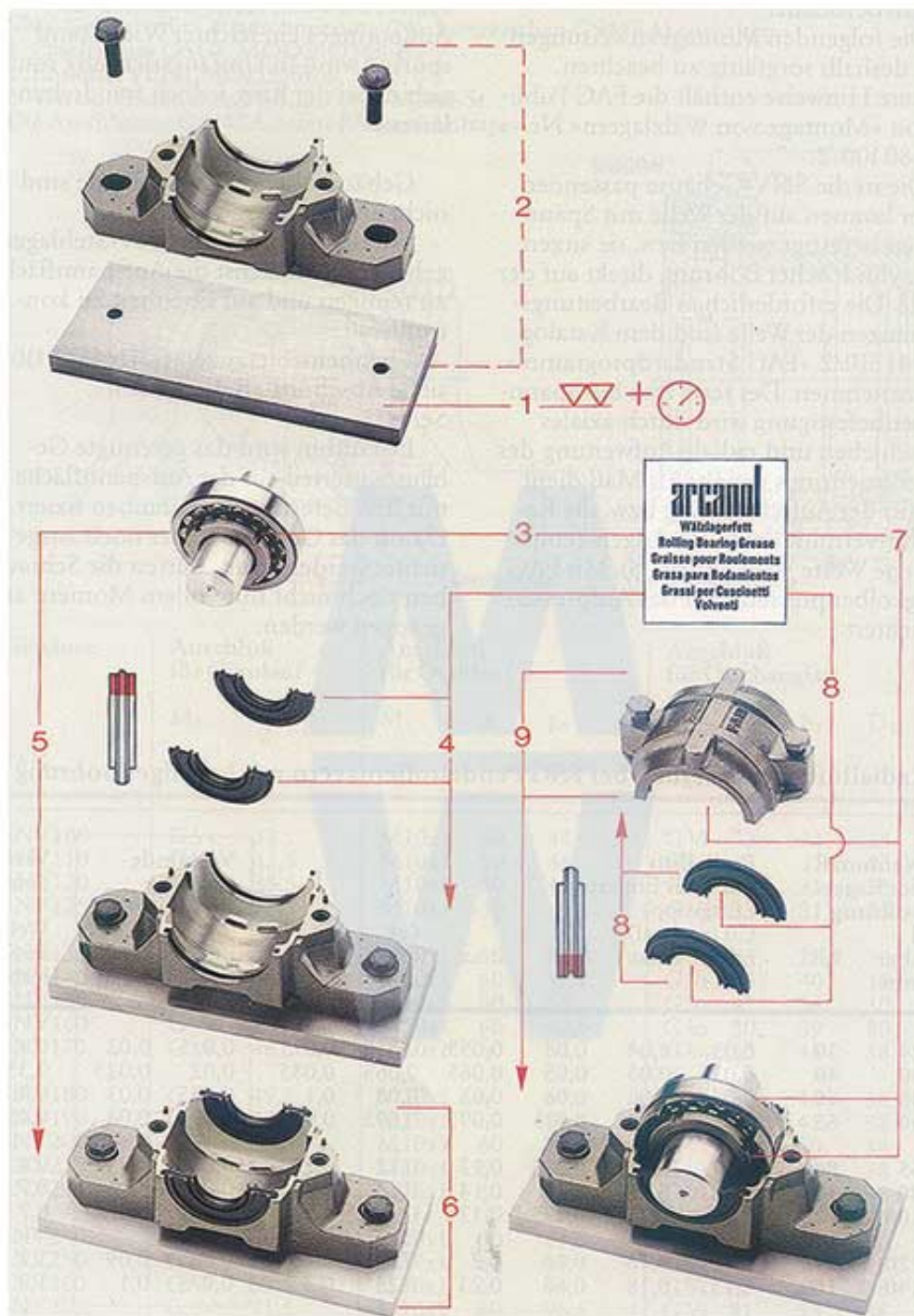

SNV-Husene fås fra størrelse SNV052 til SNV340, som dækker aksler fra 19,05mm til 160mm. Til husene findes der forskellige tætninger og dæksler.

FAG's todelte huse og lejer



Lejerne som har betegnelsen f.eks. 222sm55t er specielle og findes fra $\varnothing 55\text{mm}$ til 180mm.

Dette program skaffes på forespørgsel.

Her er nogle eksempler på FAG's betegnelser:

Enradede sporkuglelejer



618, 160, 161
60, 62, 622, 63, 623, 64

ZR .ZR RSR .RSR

Enradede vinkelkontaktkuglelejer · toradede vinkelkontaktkuglelejer · Spindellejer · Firepunktslejer



72B, 73B

32B, 33B

32, 33

33DA

B719, B70
B72

HSS719, HSS70
HCS719, HCS70

QJ2, QJ3

N2

Sfæriske kuglelejer med cylindriske og koniske borer · Klembøsninger



12, 22
13, 23

22.2RS
23.2RS

12K, 22K
13K, 23K

22K.2RS

112, 113

klembøsninger

Enradede cylindriske rullelejer · toradede cylindriske rullelejer · nålelejer

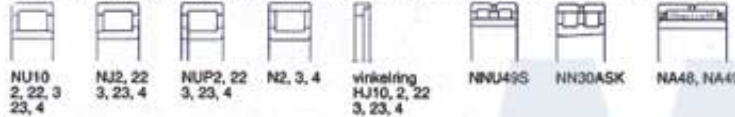

NU10
2, 22, 3
23, 4

NJ2, 22
3, 23, 4

NUP2, 22
3, 23, 4

N2, 3, 4

vinkelring
HJ10, 2, 22
3, 23, 4

NNU49S

NN30ASK

NA48, NA49

Koniske rullelejer · sammenpassede koniske rullelejer · koniske rullelejer i tommemål



329, 320, 330, 331, 302
322, 332, 303, 313, 323

313N11CA

AK, K, KH, KHM, KL, KLM
(tommemål)

Enradede sfæriske rullelejer med cylindriske og koniske borer · klembøsninger · toradede sfæriske rullelejer med cylindriske og koniske borer · klembøsninger og aftræksbøsninger



202, 203

202K
203K

klembøsninger

239, 230, 240, 231, 241
222, 232, 213, 223, 233

239K, 230K, 231K, 222K
232K, 213K, 223K
240K30, 241K30

klembøsninger

aftræksbøsninger

Enkelt-og dobbeltvirkende axial-sporkugleleje · enkelt-og dobbeltvirkende axial vinkelkontaktkuglelejer

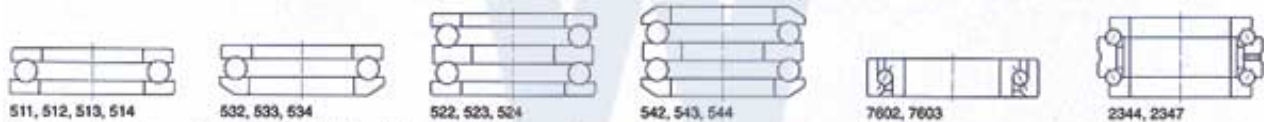

511, 512, 513, 514

532, 533, 534

522, 523, 524

542, 543, 544

7602, 7603

2344, 2347

Axial-cylindriske rullelejer · Axial-sfæriske rullelejer



811, 812

292E, 293E, 294E

Spænderingslejer · stålgehuse · flangelejhuse



162

362B

562

762B.2RSR

SG2S

SB2

FG2S

FB2

Klembøsninger · aftræksbøsninger · akselmøtrikker · sikringsblik · kugler og cylindriske ruller



H39, H30, H31, H2, H32, H3, H23
med møtrik og sikringsblik

H39, H30, H31, H2, H32, H3, H23
med møtrik og sikringsbøjle

AH39, AH30, AH31, AH32
AH3, AH23, AH240, AH241

HM30, HM31
HM, HML, HMLL
KM, KML

MB
MBL

MS30
MS31

KU

ZRO

Lejehuse



SNV
S30K

SD31TS

LOE2
LOE3
LOE5
LOE6

VRE3

F112

F5

Lejefedt FAG Arcanol · andre produkter

FAG'S EFTERBETEGNELSER

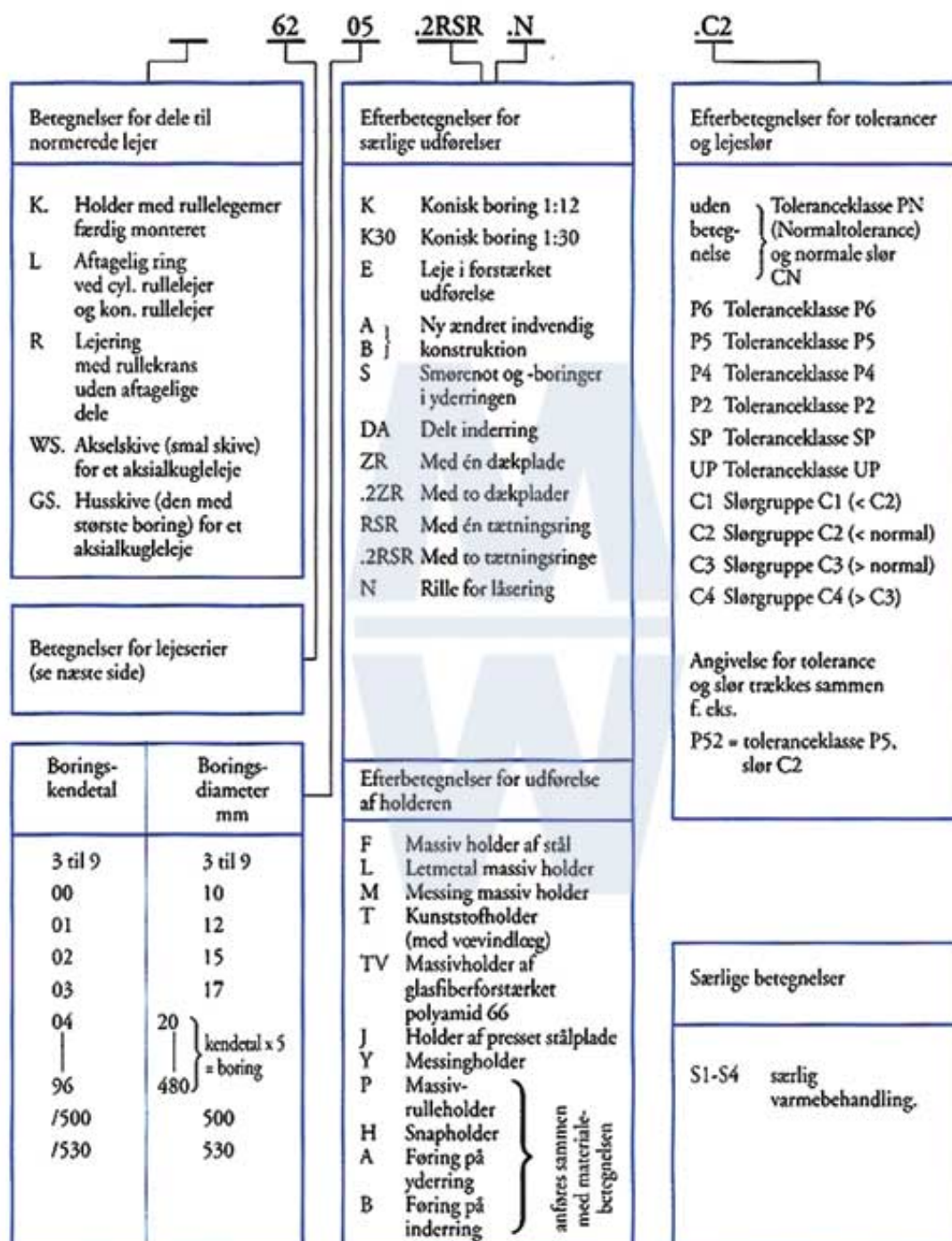

Karakteristiske anvendelsesområder for ARCANOL-fedt.

ARCANOL
DIN 51 502
Fortykkelse-
middel
Grundolievis-
kositet v/40gr
Konsistens-
klasse (NLGI)
Driftstemp.

	L78V	L71V	L135V	L186V	L223V	L74V	L12V	L79V
	K2K-30	K3N-30	KP2N-40	KP2K-20	KP2N-10	KE2K-40	K2P-30	KFK2U-30
	Lithiumsæbe	Lithiumsæbe	Lithiumsæbe med EP-tilsætninger	Lithiumsæbe med EP-tilsætninger	Lithiumsæbe med EP-tilsætninger	Specialsæbe	Polyurinstof	Syntetisk
	ISO VG 100	ISO VG 100	85	ISO VG 460	ISO VG 1 000	ISO VG 22	ISO VG 100	390
	2	3	2	2	2	2	2	2
	-30..+130	-30..+140	-40..+150	-20..+140	-10..+140	-40..+120	-30..+160	-30..+270
	Standardfedt for lejer ø D ≤ 62 mm i: -små el-motorer -landbrugs- og byggeri-maskiner -husholdings-maskiner	Standardfedt for lejer ø D > 62 mm i: -store el-motorer -autohjullevler -ventilatorer	Specialfedt for lejer i: -valseværker -byggeri-maskiner -autolejer -skønnekøretøjer -spinde- og slibespindler ved: -højt omdrejningstal -høj belastning -høj temperatur	Specialfedt for lejer i: -minedrifts-maskiner -byggeri-maskiner -maskiner for oscillerende bevægelse ved: -højeste belastning -middelhøje omdrejningstal -middelhøj temperatur	Specialfedt for lejer i: -maskiner lignende som ved L186V, fortrinsvis ved stødbelastninger og store lejer ved: -højeste belastning -lavt omdrejningstal	Specialfedt for lejer i: -værktøj-maskiner -spindellevringer -instrumenter ved: -højt omdrejningstal -lav temperatur	Specialfedt for lejer i: -koblinger -el-motorer -generatorer ved: -høj temperatur	Specialfedt for lejer i: -løberuller i bageri-maskiner -stempel-pindsløvninger i kompressorer -ovnvogne -kemiske anlæg ved: -højeste temperatur -kemisk aggressive omgivelser

Karakteris-
tiske anvend-
elsesområder

4 gode grunde til at bruge ARCANOL:

- Fejlagtig smøring forårsager over 40% af alle lejeskader
- Mere end 80% af alle rulningslejer fedtsmøres
- Brugeren har brug for gode smøremidler og anvisninger
- ARCANOL-fedt sikrer fuld udnyttelse af lejets ydeevne

ARCANOL-fedt's egenskaber

L78V	L71V	L135V	L186V	L223V	L74V	L12V	L79V
K2K-30	K3N-30	KP2N-40	KP2K-20	KP2N-10	KE2K-40	K2P-30	KFK2U-30
Lithiumsæbe	Lithiumsæbe	Lithiumsæbe med EP-tilsætninger	Lithiumsæbe med EP-tilsætninger	Lithiumsæbe med EP-tilsætninger	Specialsæbe	Polyurinstof	Syntetisk
ISO VG 100	ISO VG 100	85	ISO VG 460	ISO VG 1 000	ISO VG 22	ISO VG 100	390
2	3	2	2	2	2	2	2
-30..+130	-30..+140	-40..+150	-20..+140	-10..+140	-40..+120	-30..+160	-30..+270

Lav temp.

Høj temp.

Lav friktion
høje omdrejn.

Stor belastn.
laveomdrejn.

Svingninger

Tætnings-
forbedrende

Egnethed for
eftersmøring

<input type="radio"/>	<input type="radio"/>	<input checked="" type="radio"/>	<input type="radio"/>	<input type="radio"/>	<input checked="" type="radio"/>	<input checked="" type="radio"/>	<input checked="" type="radio"/>
<input type="radio"/>	<input type="radio"/>	<input checked="" type="radio"/>	<input type="radio"/>	<input type="radio"/>	<input checked="" type="radio"/>	<input checked="" type="radio"/>	<input checked="" type="radio"/>
<input type="radio"/>	<input type="radio"/>	<input checked="" type="radio"/>	<input type="radio"/>	<input type="radio"/>	<input checked="" type="radio"/>	<input checked="" type="radio"/>	<input type="radio"/>
<input type="radio"/>	<input type="radio"/>	<input checked="" type="radio"/>	<input checked="" type="radio"/>	<input checked="" type="radio"/>	<input type="radio"/>	<input checked="" type="radio"/>	<input checked="" type="radio"/>
<input type="radio"/>	<input checked="" type="radio"/>	<input checked="" type="radio"/>	<input checked="" type="radio"/>	<input checked="" type="radio"/>	<input type="radio"/>	<input checked="" type="radio"/>	<input type="radio"/>
<input type="radio"/>	<input checked="" type="radio"/>	<input type="radio"/>	<input type="radio"/>	<input type="radio"/>	<input checked="" type="radio"/>	<input checked="" type="radio"/>	<input checked="" type="radio"/>
<input checked="" type="radio"/>	<input type="radio"/>	<input checked="" type="radio"/>	<input checked="" type="radio"/>	<input checked="" type="radio"/>	<input checked="" type="radio"/>	<input checked="" type="radio"/>	<input checked="" type="radio"/>



meget store krav



store krav



små krav

Kugler af
-kuglelejestål
-rustfri stål
-rustfri og syrefast stål



Kugler af:
-kunststof



Kuglelejer af
-kunststof
-rustfri stål
-keramik



FAG's spindellejer



B7008C.T.P4S.UL

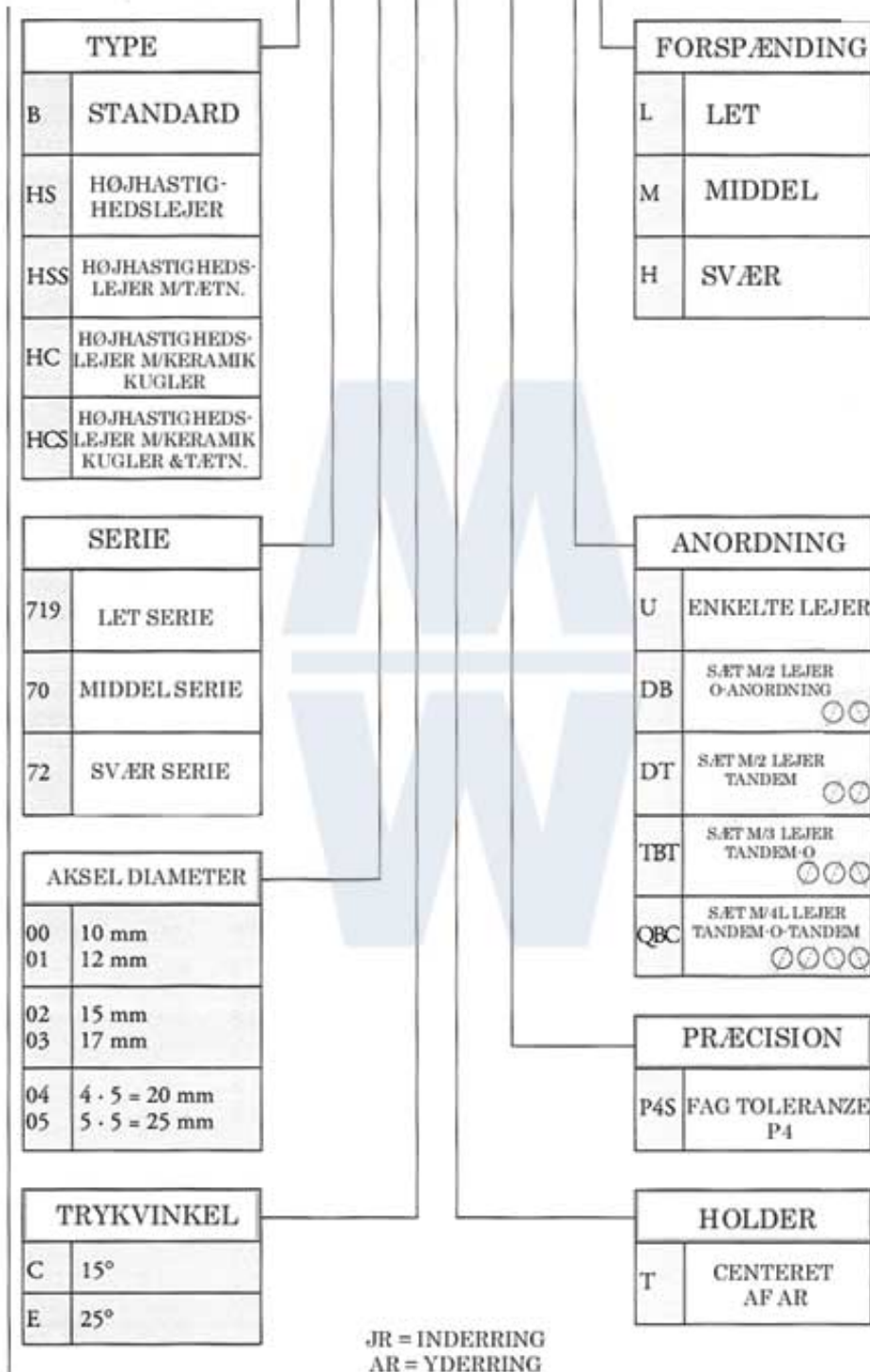

Såfremt De har andre betegnelser fra andre fabrikater er De velkommen til at kontakte os for oversætning.

Som INA forhandler har vi også nålelejer på lager.

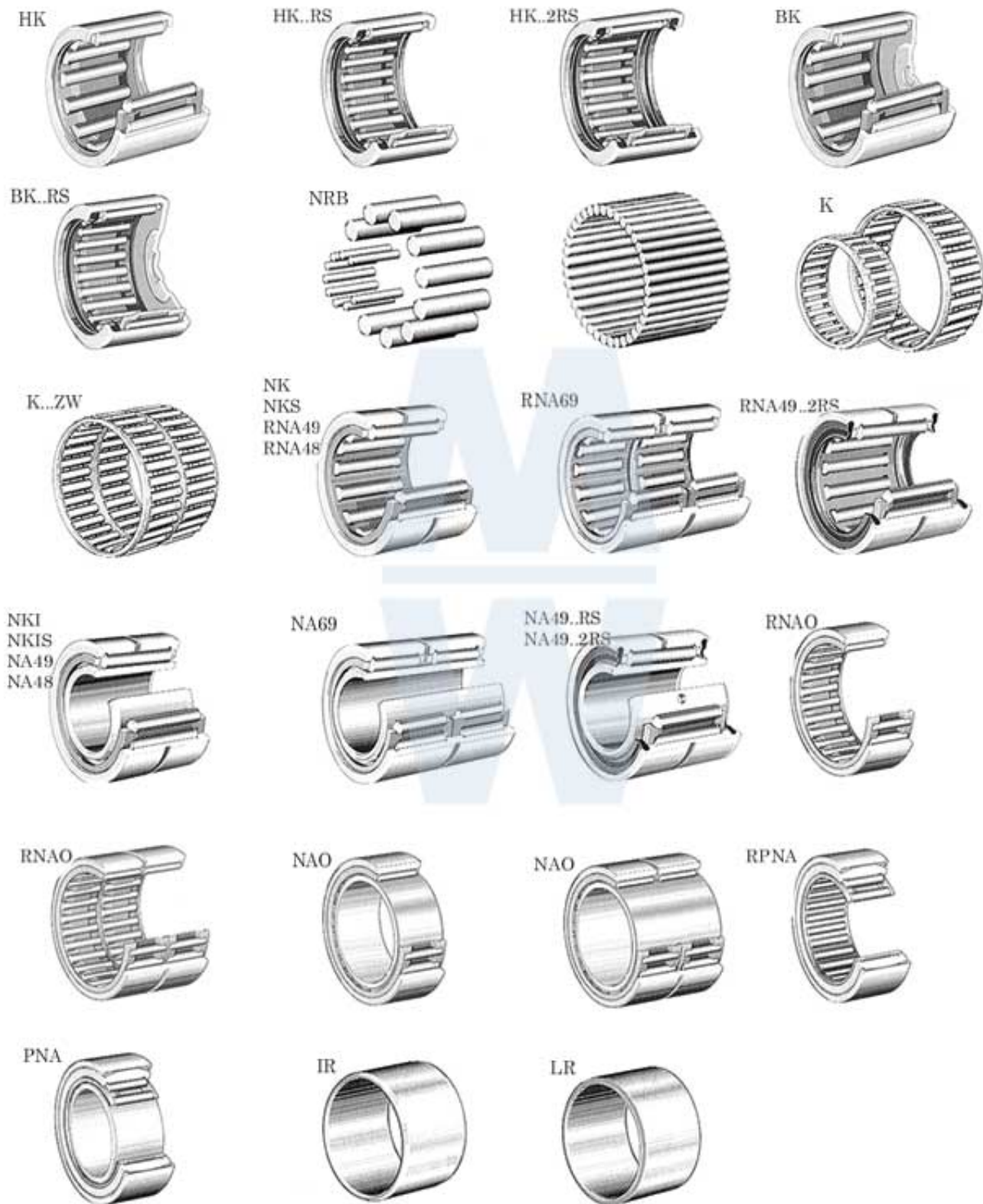

NX
NX..Z

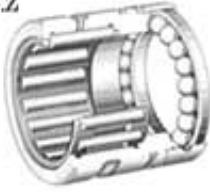

NKX
NKX..Z



NKXR
NKXR..Z



NKIA



NKIB



SL02 48
SL02 49



SL01 48
SL01 49



SL18 18
SL18 29
SL18 30
SL18 22
SL18 50



SL19 23



LSL19 23
ZSL19 23



SL04 50..PP
SL04..PP



AXK
AXW



K 811
K 812
K 893
K 894



811
812
893
894



AS



GS
WS



LS



ZKLN..2RS



ZKLN..2Z



ZKLN..2RS 2AP

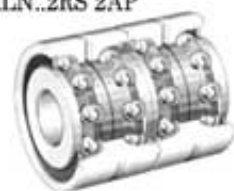

ZKLF..2RS
ZKLF..2RS PE



ZKLF..2Z



ZKLF..2RS 2AP

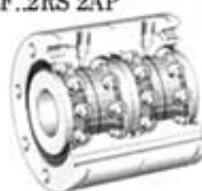

STO
RSTO



NA22...2RS
RNA22...2RS



NATR...PP
NATV...PP

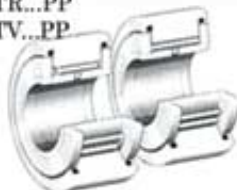

NATR



NUTR



PWTR...2RS



KR..PP
KR



KRE..PP



KRV..PP



NUKR
NUKRE



PWKR...2RS



PWKRE...2RS



Såfremt de ønsker yderligere infomation om nålelejer
er de velkommen til at kontakte os.

LEDLEJER

GE..DO



GE..DO-2RS



GE..FO



GE..FO-2RS



GE..LO



GE..HO-2RS



GE..ZO



GE..PB



GE..SX



GE..AX



GE..UK



GE..UK-2RS



GE..DW



GE..FW



GE..FW-2RS



GE..PW



GE..SW



GE..AW



ZGB..



GIR..DO
GIR..DO-2RS
GIL..DO
GIL..DO-2RS



GAR..DO
GAR..DO-2RS
GAL..DO
GAL..DO-2RS



GIKFR..PB
GIKFL..PB



GAKFR..PB
GAKFL..PB



GIHN-K.LO



GIHO-K.DO



GIHR-K.DO



GK..DO



GF..DO



GIR..UK
GIR..UK-2RS
GIL..UK
GIL..UK-2RS



GAR..UK
GAR..UK-2RS
GAL..UK
GAL..UK-2RS



GIKFR..PW
GIPFR..PW
GIKFL..PW



GAKFR..PW
GAKFL..PW





INDUKTIONSVARMERE

NILOSRINGE



LEJEMONTAGESÆT

AFTRÆKKER

